

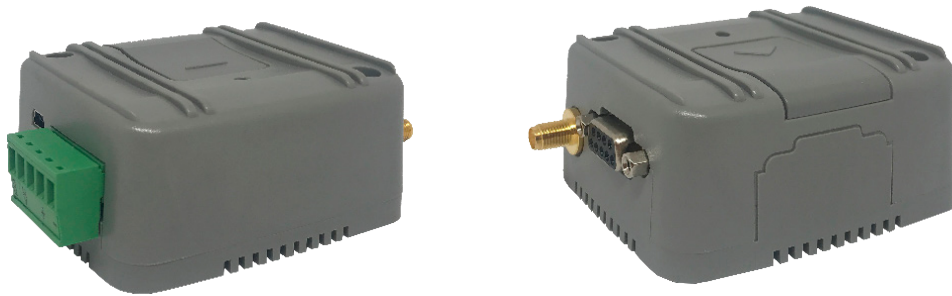

#WeAreConnectivity  
SMART SOLUTIONS FOR A CHANGING WORLD



## MTX-T

HARDWARE

# USERGUIDE



[www.mtxm2m.com](http://www.mtxm2m.com)

# Index

<b>GENERAL NOTES .....</b>	<b>5</b>
<b>IMPORTANT INFORMATION .....</b>	<b>5</b>
<b>SERVICE AND SUPPORT .....</b>	<b>5</b>
<b>REVISION INFORMATION .....</b>	<b>6</b>
<b>INTRODUCTION .....</b>	<b>7</b>
1. Description .....	7
2. Highlights.....	8
3. Product Label .....	10
4. Main Features and Services .....	11
4.1 Key features at a glance .....	11
4.2 Operating modes.....	17
4.3 Power consumption .....	19
4.4 RF antenna interface description .....	20
4.5 SIM card.....	30
5. Precautions .....	31
6. Block Diagram.....	32
7. Hardware Revisions .....	33
<b>MECHANICAL DESCRIPTION .....</b>	<b>34</b>
1. Overview .....	34
1.1 Models with 5-way plug-in 5.00mm pitch terminal block.....	34
2. Dimensions (mm) .....	35
<b>ELECTRICAL AND ENVIRONMENTAL CHARACTERISTICS.....</b>	<b>36</b>
1. Electrical specifications.....	36
1.1 Power supply.....	36
1.2 RS232 interface.....	37
1.3 RS485 interface.....	38
1.4 Digital input .....	39
2. Operating Temperatures .....	40
3. Storage Conditions .....	41

<b>INTERFACE DESCRIPTION .....</b>	<b>42</b>
1. Power Supply Connector .....	43
1.1 5-way plug-in 5.00mm pitch terminal block .....	43
2. Micro USB Connector .....	44
3. DB9 Connector: I/O port .....	45
3.1 RS232 .....	45
3.2 Digital input .....	46
4. RS485 bus .....	47
5. GSM/GPRS/UMTS Antenna Connector .....	48
6. SIM Card Reader .....	49
7. Real Time Clock .....	50
8. GPS .....	51
8.1 GPS antenna connector .....	51
8.2 GPS application interface .....	51
8.3 GPS antenna interface characteristics .....	51
9. Firmware Updates .....	53
<b>OPERATION.....</b>	<b>54</b>
1. Switching on the modem. New “Automatic restart after shutdown” feature.....	54
2. Status LEDs.....	55
<b>EMBEDDED APPLICATIONS.....</b>	<b>57</b>
1. MTX-Tunnel Software Application .....	59
<b>SAFETY AND PRODUCT CARE.....</b>	<b>61</b>
1. Safety Instructions .....	61
2. General Precautions.....	62
3. SIM Card Precautions.....	63
4. Antenna Precautions .....	64
5. Radio Frequency (RF) Exposure and SAR .....	65
6. Personal Medical Devices .....	66
<b>MODEM INSTALLATION.....</b>	<b>67</b>
1. Where to Install the Modem.....	67
1.1 Environmental conditions .....	67
1.2 Signal strength .....	67

1.3 Connections of components to MTX-T device .....	67
1.4 Network and subscription.....	67
2. How to Install the Modem .....	68
2.1 Power supply.....	68
2.2 Securing the modem .....	68
3. Antenna .....	69
3.1 General .....	69
3.2 Antenna type .....	69
3.3 Antenna placement.....	69
3.4 The antenna cable .....	70
3.5 Possible communications disturbances.....	70
<b>CONFORMITY ASSESSMENT .....</b>	<b>71</b>
1. RED Declaration of Conformity .....	71
2. FCC Compliant .....	72
2.1 SAR information .....	72
<b>DECLARACIÓN DE CONFORMIDAD .....</b>	<b>74</b>
1. Declaración de conformidad RED.....	74
2. Conformidad FCC.....	75
2.1 Tasa de absorción específica (SAR) .....	75
<b>REGULATORY AND TYPE APPROVAL INFORMATION.....</b>	<b>77</b>
1. Directives and Standards.....	77
2. SAR Requirements Specific to Portable Mobiles.....	80
3. SELV Requirements .....	81
<b>ROHS STATEMENT .....</b>	<b>82</b>
<b>DISPOSAL OF OLD ELECTRICAL AND ELECTRONIC EQUIPMENT .....</b>	<b>83</b>
<b>ABBREVIATIONS.....</b>	<b>84</b>
<b>AT COMMAND SUMMARY.....</b>	<b>90</b>
<b>ACCESSORIES .....</b>	<b>99</b>
<b>SALES CONTACT.....</b>	<b>100</b>

# GENERAL NOTES

Product is deemed accepted by recipient and is provided without interface to recipient's products. The documentation and/or product are provided for testing, evaluation, integration and information purposes. The documentation and/or product are provided on an "as is" basis only and may contain deficiencies or inadequacies. The documentation and/or product are provided without warranty of any kind, express or implied. To the maximum extent permitted by applicable law, Matrix Electronica S.L.U. further disclaims all warranties; including without limitation any implied warranties of merchantability, completeness, fitness for a particular purpose and non-infringement of third-party rights. The entire risk arising out of the use or performance of the product and documentation remains with recipient. This product is not intended for use in life support appliances, devices or systems where a malfunction of the product can reasonably be expected to result in personal injury. Applications incorporating the described product must be designed to be in accordance with the technical specifications provided in these guidelines. Failure to comply with any of the required procedures can result in malfunctions or serious discrepancies in results.

Furthermore, all safety instructions regarding the use of mobile technical systems, including GSM products, which also apply to cellular phones, must be followed. Matrix Electronica S.L.U. or its suppliers shall, regardless of any legal theory upon which the claim is based, not be liable for any consequential, incidental, direct, indirect, punitive or other damages whatsoever (including, without limitation, damages for loss of business profits, business interruption, loss of business information or data, or other pecuniary loss) arising out the use of or inability to use the documentation and/or product, even if Matrix Electronica S.L.U. has been advised of the possibility of such damages. The foregoing limitations of liability shall not apply in case of mandatory liability, e.g. under the Spanish Product Liability Act, in case of intent, gross negligence, injury of life, body or health, or breach of a condition which goes to the root of the contract. However, claims for damages arising from a breach of a condition, which goes to the root of the contract, shall be limited to the foreseeable damage, which is intrinsic to the contract, unless caused by intent or gross negligence or based on liability for injury of life, body or health. The above provision does not imply a change on the burden of proof to the detriment of the recipient. Subject to change without notice at any time. The interpretation of this general note shall be governed and construed according to Spanish law without reference to any other substantive law.

# IMPORTANT INFORMATION

This technical description contains important information for the startup and use of the MTX-T modem. Read it carefully before you start working with the MTX-T device. The warranty will be void should damage occur due to non-compliance with these instructions for use. We cannot accept any responsibility for consequential loss.

# SERVICE AND SUPPORT

To contact customer support please contact your local distributor/sales agent or use the details below:

Address: Alejandro Sánchez 109, 28019 Madrid (Spain)  
Email: [gsm-support@matrix.es](mailto:gsm-support@matrix.es)  
Website: [mtxm2m.com](http://mtxm2m.com)

# REVISION INFORMATION

REVISION	DATE	AUTHOR	CHANGES
1.0	2019/02	EGG	Initial release

# INTRODUCTION

## ● 1. Description

The MTX-T devices are an innovative and powerful all-in-one solution for the most demanding M2M and Internet of Things applications, enabling GSM data & voice communication, SMS, fax and 2G/3G/4G high speed cellular data transmission.

The MTX-T modems are Java J2ME programmable and have a complete set of interfaces (RS232, RS485, USB, IO) avoiding need for further hardware components, shortening time to market and reducing costs.

Please read section Introduction 3 (Features by Model) to view the specific features of each device.

The MTX-T family is industrially featured: the unit can be used in industrial environments due to its extended operating temperature range. It also features an automatic restart after shutdown function in case of power glitches or faulty conditions.

The MTX-T are a self-contained modems with its own SIM card holder, USB 2.0 High Speed and RS232/485 interfaces (among others), which minimize the need for further hardware development. This device can be used as a powerful and flexible device that can be integrated in a wide range of telemetry applications that rely on the remote exchange of data, SMS or faxes via the GSM cellular network.

The five-band functionality allows for operation in all relevant GSM frequencies across the world. Local European and America economic variants are available. When UMTS/3G network operation is not present, the MTX-T can operate in lower speed modes such EDGE Class 12 (max. 237kbps DL, max. 237kbps UL) or GPRS Class 12 (max. 85.6kbps DL, max. 85.6kbps).

The MTX-T devices can also be controlled via AT commands and standard interfaces such us USB 2.0 High Speed or RS232 with Linux and Windows® drivers.







The MTX-T family is RoHS & WEEE compliant and it is manufactured following the ISO 9001 & ISO 14001 Quality certifications.

A full list of antennas, cables and accessory supplies are available.









The MTX-T modems are powered by an internal EHS6/8/BGS5/ELS6/5 modules.

## ● 2. Highlights





## ● HARDWARE FEATURES ●

	MTX-4G-T	MTX-3G-T	MTX-2G-T
	LTE 5 Bands (700, 800, 900, 1800, 2100MHz), GSM/GPRS/EDGE: 2 Bands (900, 1800MHz)	HSPA+: 5 Bands (800, 850, 900, 1900, 2100MHz), GSM/GPRS/EDGE: 4 Bands (850, 900, 1800, 1900MHz)	GSM 4 Bands (850, 900, 1800, 1900MHz), release 6
	LTE Cat.1: DL 10.2Mbps, UL 5.2Mbps		
	HSPA: DL 7.2Mbps, UL 5.7Mbps UMTS PS: DL 384Mbps, UL 384 Mbps, CS: DL 64Mbps, UL 64Mbps	HSPA (3GPP release 7): DL 7.2Mbps, UL 5.7Mbps; HSDPA Cat.8/HSUPA Cat.6	
	EDGE Class 12 data rates, DL: max. 237 kbps, UL: max. 237 kbps GPRS Class 12 data rates, DL: max. 85.6 kbps, UL: max. 85.6 kbps	EDGE Class 12 data rates, DL: max. 237 kbps, UL: max. 237 kbps GPRS Class 12 data rates, DL: max. 85.6 kbps, UL: max. 85.6 kbps	EDGE Class 12 data rates, DL: max. 237 kbps, UL: max. 237 kbps GPRS Class 12 data rates, DL: max. 85.6 kbps, UL: max. 85.6 kbps
	CSD data transmission up to 9.6 kbps, V.110, non-transparent	CSD data transmission up to 9.6 kbps, V.110, non-transparent	CSD data transmission up to 9.6 kbps, V.110, non-transparent
	SMS: text and PDU mode support, point-to-point MO and MT, cell broadcast	SMS: text and PDU mode support, point-to-point MO and MT, cell broadcast	SMS: text and PDU mode support, point-to-point MO and MT, cell broadcast

### Interfaces

-  4G/3G/2G connectivity
-  SIM card interface 1.8V and 3V
-  RS232
-  RS485
-  1x digital input
-  Power supply
-  GPS module (optional)
-  Operating status LEDs

### Connectors

-  SMA F antenna connectors
-  Mini USB B
-  DB9 female connector: RS232
-  5-way plug-in: RS485, power supply and digital input



### Processor

	4G	3G	2G
Flash	31MB	10MB	10MB
RAM	18MB	10MB	10MB
CPU	ARM11	ARM11	ARM11







## SOFTWARE FEATURES







### General Features

-  SIM application toolkit, 3GPP release 99
-  Control and TCP/IP stacks access via AT commands
-  Internet services: TCP, UDP, HTTP, FTP, SMTP, POP3

### Special Features

-  USB interfaces support composite modes and Linux/Mac compliant mode
-  Firmware update via USB/RS232
-  Real Time Clock with alarm functionality
-  Multiplexer according 3GPP TS 27.010
-  RLS monitoring and informal network scan

### Java Features

-  Oracle Java ME embedded 3.2
-  Compliant to CLDC 1.1 HI and IMP-NG standards
-  Capable of running multiple MIDlets in parallel with inter-MIDlet communication
-  Java standard APIs: JSR75 (FileConnection), JSR177 (CRYPTO), JSR280 (XML)
-  Accessible periphery for Java applications
-  Memory space for Java applications

### ● 3. Product Label

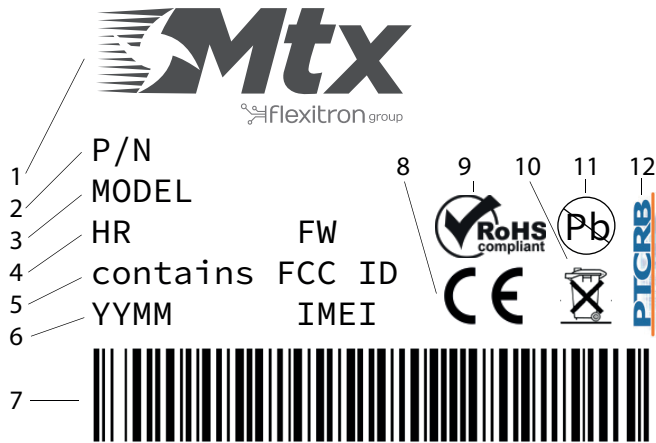

1. MTX logo
2. Part number/ordering code
3. Product name (model)
4. Hardware and firmware versions
5. FCC ID
6. Year/week of fabrication
7. Barcode (code 128) (IMEI)
8. CE logo
9. RoHS symbol
10. WEEE symbol
11. Pb-free symbol
12. PTCRB certification logo

## ● 4. Main Features and Services

The MTX-T performs a set of telecom services (TS) according to GSM standard phase 2+, ETSI and ITU-T. The services and functions of the MTX-3G-T are implemented by issuing customized applications embedded on the device, by AT commands issued internally or over the USB, RS232 or RS485 interface.

### 4.1 Key features at a glance

The MTX-3G-T is a UMTS/HSPA and also GSM/GPRS/EDGE bands mobile station with the characteristics shown in the table below.

FEATURE	IMPLEMENTATION
<b>General</b>	
Frequency bands	UMTS/HSPA+: Five band, 800/850/900/1900/2100MHz GSM/GPRS/EDGE: Quad band, 850/900/1800/1900MHz
GSM class	Small MS
Output power	Class 4 (+33dBm ±2dB) for EGSM850 Class 4 (+33dBm ±2dB) for EGSM900 Class 1 (+30dBm ±2dB) for GSM1800 Class 1 (+30dBm ±2dB) for GSM1900 Class E2 (+27dBm ± 3dB) for GSM 850 8-PSK Class E2 (+27dBm ± 3dB) for GSM 900 8-PSK Class E2 (+27dBm +3dB/-4dB) for GSM 1800 8-PSK Class E2 (+27dBm +3/-4dB) for GSM 1900 8-PSK Class E2 (+26dBm +3/-4dB) for GSM 1800 8-PSK Class 3 (+24dBm +1/-3dB) for UMTS 2100, WCDMA FDD Bdl Class 3 (+24dBm +1/-3dB) for UMTS 1900, WCDMA FDD BdII Class 3 (+24dBm +1/-3dB) for UMTS 900, WCDMA FDD BdVIII Class 3 (+24dBm +1/-3dB) for UMTS 850, WCDMA FDD BdV Class 3 (+24dBm +1/-3dB) for UMTS 800, WCDMA FDD BdVI
Power supply	Single supply voltage Maximum: 6.5 to 40V (without damaging the device)* Recommended: 7 to 35V  *(Not guaranteed over the whole temperature range / Supplies from 35 to 40V may damage the device during an extended use)
Physical	Dimensions: 78,1 x 66,8 x 37,2 mm Weight: approx. 190g
RoHS	All hardware components are fully compliant with the EU RoHS Directive

HSPA Features	
3GPP Release 6,7	DL 7.2Mbps, UL 5.7Mbps HSDPA Cat.8 / HSUPA Cat.6 data rates Compressed mode (CM) supported according to 3GPP TS25.212
UMTS Features	
3GPP Release 8	PS data rate – 384 kbps DL / 384 kbps UL CS data rate – 64kbps DL / 64 kbps UL
GSM/GPRS/EGPRS Features	
Data transfer	<p>GPRS</p> <ul style="list-style-type: none"> <li>• Multislot Class 12</li> <li>• Full PBCCH support</li> <li>• Mobile Station Class B</li> <li>• Coding Scheme 1–4</li> </ul> <p>EGPRS</p> <ul style="list-style-type: none"> <li>• Multislot Class 12</li> <li>• EDGE E2 power class for 8 PSK</li> <li>• Downlink coding schemes–CS 1-4, MCS 1-9</li> <li>• Uplink coding schemes–CS 1-4, MCS 1-9</li> <li>• SRB loopback and test mode B</li> <li>• 8-bit, 11-bit RACH</li> <li>• PBCCH support</li> <li>• 1 phase/2 phase access procedures</li> <li>• Link adaptation and IR</li> <li>• NACC, extended UL TBF</li> <li>• Mobile Station Class B</li> </ul> <p>CSD</p> <ul style="list-style-type: none"> <li>• V.110, RLP, non-transparent</li> <li>• 9.6kbps</li> <li>• USSD</li> </ul>
SMS	Point-to-point MT and MO Cell broadcast Text and PDU mode Storage: SIM card plus SMS locations in mobile equipment
Software	
AT commands	Hayes, 3GPP TS 27.007, 27.005, Gemalto M2M AT commands for RIL compatibility

Java Open Platform	<p>Java Open Platform with</p> <ul style="list-style-type: none"> <li>• JavaTM profile IMP-NG &amp; CLDC 1.1 HI</li> <li>• Secure data transmission via HTTPS/SSL</li> <li>• Multi-threading programming and multi-application execution</li> </ul> <p>Major benefits: seamless integration into Java applications, ease of programming, no need for application microcontroller, extremely cost-efficient hardware and software design – an ideal platform for industrial GSM applications.</p> <p>The memory space available for Java programs is around 8MB in the flash file system and around 6MB of RAM. Application code and data share the space in the flash file system and in the RAM.</p>
Microsoft compatibility	RIL for Pocket PC and Smartphone
SIM Application Toolkit	SAT Release 99
Firmware update	Firmware update from host application over USB

The MTX-4G-T is a LTE bands mobile station with the characteristics shown in the table below.

FEATURE	IMPLEMENTATION
<b>General</b>	
Frequency bands	GSM/GPRS/EDGE: Dual band 900/1800MHz LTE: 800 (Bd20) / 900 (Bd8) / 1800 (Bd3) / 2100 MHz (Bd1)
GSM class	Small MS
Output power (according to Release 99)	Class 4 (+32.5dBm ±2dB) for EGSM900 Class 1 (+29.5dBm ±2dB) for GSM1800 Class E2 (+26.5dBm ± 3dB) for GSM 900 8-PSK Class E2 (+26dBm +3 /-4dB) for GSM 1800 8-PSK
Output power (according to Release 8)	Class 3 (+23dBm +1dB/-2dB) for LTE 800, LTE FDD Bd20 Class 3 (+23dBm +1dB/-2dB) for LTE 900, LTE FDD Bd8 Class 3 (+23dBm +1dB/-2dB) for LTE 1800, LTE FDD Bd3 Class 3 (+23dBm +1dB/-2dB) for LTE 2100, LTE FDD Bd1
Power supply	<p>Single supply voltage Maximum: 6.5 to 40V (without damaging the device)* Recommended: 7 to 35V</p> <p>*(Not guaranteed over the whole temperature range / Supplies from 35 to 40V may damage the device during an extended use)</p>

Operating temperature (board temperature)	Normal operation: -30°C to +85°C Extended operation: -40°C to +90°C
Physical	Dimensions: 27.6mm x 25.4mm x 2.2mm Weight: approx. 3.5g
RoHS	All hardware components fully compliant with EU RoHS Directive
<b>LTE Features</b>	
3GPP Release 9	UE CAT 1 supported DL 10.2Mbps, UL 5.2Mbps
<b>GSM/GPRS/EGPRS Features</b>	
Data transfer	<p>GPRS</p> <ul style="list-style-type: none"> <li>• Multislot Class 12</li> <li>• Full PBCCH support</li> <li>• Mobile Station Class B</li> <li>• Coding Scheme 1-4</li> </ul> <p>EGPRS</p> <ul style="list-style-type: none"> <li>• Multislot Class 12</li> <li>• EDGE E2 power class for 8 PSK</li> <li>• Downlink coding schemes-CS 1-4, MCS 1-9</li> <li>• Uplink coding schemes-CS 1-4, MCS 1-9</li> <li>• SRB loopback and test mode B</li> <li>• 8-bit, 11-bit RACH</li> <li>• PBCCH support</li> <li>• 1 phase/2 phase access procedures</li> <li>• Link adaptation and IR</li> <li>• NACC, extended UL TBF</li> <li>• Mobile Station Class B</li> </ul>
SMS	Point-to-point MT and MO Cell broadcast Text and PDU mode Storage: SIM card plus SMS locations in mobile equipment
<b>Software</b>	
AT commands	Hayes, 3GPP TS 27.007, 27.005, Gemalto M2M AT commands for RIL compatibility

Java Open Platform	<p>Java Open Platform with</p> <ul style="list-style-type: none"> <li>• JavaTM profile IMP-NG &amp; CLDC 1.1 HI</li> <li>• Secure data transmission via HTTPS/SSL</li> <li>• Multi-threading programming and multi-application execution</li> </ul> <p>Major benefits: seamless integration into Java applications, ease of programming, no need for application microcontroller, extremely cost-efficient hardware and software design – an ideal platform for industrial GSM applications.</p> <p>The memory space available for Java programs is around 8MB in the flash file system and around 6MB of RAM. Application code and data share the space in the flash file system and in the RAM.</p>
Microsoft compatibility	RIL for Pocket PC and Smartphone
SIM Application Toolkit	SAT letter classes b, c, e; with BIP
Firmware update	Generic update from host application over ASCO or USB modem

The following characteristics are common to MTX-3G-T and MTX-4G-T.

Interfaces (depending on models)	
USB	Supports a USB 2.0 High Speed (480Mbit/s) device interface, Full Speed (12Mbit/s) compliant
RS232 (4-wire)	Adjustable baud rates: 1200bps to 921600bps Autobauding: 1200 to 230400bps Supports RTS/CTS hardware flow control Multiplex ability according to GSM 07.10 Multiplexer Protocol
RS485	Adjustable baud rates: 1200bps to 921600bps Autobauding: 1200 to 230400bps Half-duplex
I/O	1x digital input
Status	LED to indicate network connectivity status
UICC interface	Supported chip cards: UICC/SIM/USIM 3V, 1.8V
Antenna	50 Ohms. GSM/UMTS main antenna

## Power on/off, Reset

Power on/off	Automatic switch-on at power supply Switch off by AT command Switch off by hardware signal TURN_OFF Automatic switch-off in case of high temperature or voltage conditions
Software Reset	Orderly shutdown and reset by AT command
Hardware Reset	Emergency reset by hardware

## Special Features

Antenna	SAIC/DARP Rx Diversity (receiver type 3i – 64-QAM)/MIMO
---------	--



## 4.2 Operating modes

The table below briefly summarizes the MTX-3G-T operating modes referred to in the next chapters.

LIMITS	FUNCTION	
Normal operation	GSM/GPRS/UMTS/HSPA	Power saving automatically activated when no calls are in progress, the USB connection is suspended by the host or not present, and there is no active communication via ASCO.
	GSM/GPRS/UMTS/HSPA	Power saving is disabled if a USB connection is not suspended, but no call is in progress.
	GSM TALK/GSM DATA	Connection between 2 subscribers in progress. Power consumption depends on the GSM network coverage and several connection settings (e.g. DTX off/on, FR/EFR/HR, hopping sequences and antenna connection). The following applies when power is to be measured in TALK_GSM mode: DTX off, FR and no frequency hopping.
	GPRS DATA	GPRS data transfer in progress. Power consumption depends on network settings (e.g. power control level), uplink/downlink data rates and GPRS configuration (e.g. used multislot settings).
	EGPRS DATA	EGPRS data transfer in progress. Power consumption depends on network settings (e.g. power control level), uplink/downlink data rates and EGPRS configuration (e.g. used multislot settings).
	UMTS TALK/UMTS DATA	UMTS data transfer in progress. Power consumption depends on network settings and data transfer rate.
	HSPA DATA	HSPA DATA
Airplane mode	Airplane mode shuts down the radio, causes the modem to log off from the GSM/GPRS network, and disables all AT commands whose execution requires radio connection. Airplane mode can be controlled by AT command.	

The table below briefly summarizes the MTX-4G-T operating modes referred to in the next chapters.

LIMITS	FUNCTION	
Normal operation	GSM/GPRS/LTE	Power saving set automatically when no call is in progress and the USB connection is suspended by host or not present and no active communication via ASCO.

	GSM/GPRS/LTE	Power saving disabled or an USB connection not suspended, but no call in progress.
	GSM TALK/GSM DATA	Connection between two subscribers is in progress. Power consumption depends on the GSM network coverage and several connection settings (e.g. DTX off/on, FR/EFR/HR, hopping sequences and antenna connection). The following applies when power is to be measured in TALK_GSM mode: DTX off, FR and no frequency hopping.
	GPRS DATA	GPRS data transfer in progress. Power consumption depends on network settings (e.g. power control level), uplink / downlink data rates and GPRS configuration (e.g. used multislots settings).
	EGPRS DATA	EGPRS data transfer in progress. Power consumption depends on network settings (e.g. power control level), uplink / downlink data rates and EGPRS configuration (e.g. used multislots settings).
	LTE DATA	LTE data transfer in progress. Power consumption depends on network settings (e.g. TPC Pattern) and data transfer rate.
Power Down		Normal shutdown after sending the power down command. Only a voltage regulator is active for powering the RTC. Software is not active. Interfaces are not accessible. Operating voltage remains applied.
Airplane mode		Airplane mode shuts down the radio part of the module, causes the module to log off from the network and disables all AT commands whose execution requires a radio connection. Airplane mode can be controlled by AT command.

### 4.3 Power consumption

It is recommend to use 12V/1.5A power supply (IIN2)

DESCRIPTION	CONDITIONS		TYPICAL
Average GSM/GPRS supply current	GPRS Data transfer GSM850/900; PCL=5; 1Tx/4Rx	ROPR=4 (max. reduction)	67mA
		ROPR=0 (no reduction)	
	GPRS Data transfer GSM850/900; PCL=5; 2Tx/3Rx	ROPR=4 (max. reduction)	84.5mA
		ROPR=0 (no reduction)	115mA
	GPRS Data transfer GSM850/900; PCL=5; 4Tx/1Rx	ROPR=4 (max. reduction)	90mA
		ROPR=0 (no reduction)	205mA
	EDGE Data transfer GSM850/900; PCL=5; 1Tx/4Rx	ROPR=4 (max. reduction)	50mA
		ROPR=0 (no reduction)	
	EDGE Data transfer GSM850/900; PCL=5; 2Tx/3Rx	ROPR=4 (max. reduction)	64.5mA
		ROPR=0 (no reduction)	81mA
	EDGE Data transfer GSM850/900; PCL=5; 4Tx/1Rx	ROPR=4 (max. reduction)	97mA
		ROPR=0 (no reduction)	136mA
	GPRS Data transfer GSM1800/1900; PCL=0; 1Tx/4Rx	ROPR=4 (max. reduction)	52mA
		ROPR=0 (no reduction)	
	GPRS Data transfer GSM1800/1900; PCL=0; 2Tx/3Rx	ROPR=4 (max. reduction)	57mA
		ROPR=0 (no reduction)	85mA
GPRS Data transfer GSM1800/1900; PCL=0; 4Tx/1Rx	ROPR=4 (max. reduction)	67mA	
	ROPR=0 (no reduction)	145mA	

Average WCDMA supply current supply current	EDGE Data transfer GSM1800/1900; PCL=0; 1Tx/4Rx	ROPR=4 (max. reduction)	45mA
		ROPR=0 (no reduction)	
	EDGE Data transfer GSM1800/1900; PCL=0; 2Tx/3Rx	ROPR=4 (max. reduction)	62mA
		ROPR=0 (no reduction)	70mA
	EDGE Data transfer GSM1800/1900; PCL=0; 4Tx/1Rx	ROPR=4 (max. reduction)	95mA
		ROPR=0 (no reduction)	115mA
	UMTS Data transfer Band I @ 23dBm		132mA
	UMTS Data transfer Band II @ 23dBm		150mA
	UMTS Data transfer Band V/VI @ 23dBm		150mA
	UMTS Data transfer Band VIII @ 23dBm		152mA
HSPA Data transfer Band I @ 23dBm		132mA	
HSPA Data transfer Band II @ 23dBm		150mA	
HSPA Data transfer Band V/VI @ 23dBm		150mA	
HSPA Data transfer Band VIII @ 23dBm		152mA	

1. With an impedance of ZLOAD=500hm at the antenna port
2. Measurements start 6 minutes after switching ON the modules.  
Average times: transfer modes – 1.5 minutes.  
Communication tester settings: no neighbor cells, no cell reselection etc., RMC (reference measurement channel)

#### 4.4 RF antenna interface description

The table below briefly summarizes the RF Antenna interface GSM/UMTS (dBm).

PARAMETER		CONDITIONS	MIN	TYP
UMTS/HSPA Connectivity		Band I, II, V, VI, VIII		
Receiver Input Sensitivity @ ARP		UMTS 800/850 Band VI/V	-104.7/-106.7	-110
		UMTS 900 Band VIII	-103.7	-110
		UMTS 1900 Band II	-104.7	-109
		UMTS 2100 Band I	-106.7	-110
RF Power @ ARP with 500hm Load		UMTS 800/850 Band VI/V	21 (max 25)	24
		UMTS 900 Band VIII	21 (max 25)	24
		UMTS 1800 Band III	21 (max 25)	24
		UMTS 2100 Band I	21 (max 25)	24
GPRS Coding Schemes		Class 12, CS1 to CS4		
EGPRS		Class 12, MCS1 to MCS9		
GSM Class		Small MS		
Static Receiver Input Sensitivity @ ARP		GSM 850/E-GSM 900	-102	-109
		GSM 1800/GSM 1900	-102	-108
RF Power @ ARP with 500hm Load	GSM	GSM 850/E-GSM 900		33
		GSM 1800/GSM 1900		30
RF Power @ ARP with 500hm Load, (ROPR = 0, i.e. no reduction)	GPRS, 1 TX	GSM 850/E-GSM 900		33
		GSM 1800/GSM 1900		30
	EDGE, 1 TX	GSM 850/E-GSM 900		27
		GSM 1800/GSM 1900		26

	GPRS, 2 TX	GSM 850/E-GSM 900	33	
		GSM 1800/GSM 1900	30	
	EDGE, 2 TX	GSM 850/E-GSM 900	27	
		GSM 1800/GSM 1900	26	
	GPRS, 3 TX	GSM 850/E-GSM 900	33	
		GSM 1800/GSM 1900	30	
	EDGE, 3 TX	GSM 850/E-GSM 900	27	
		GSM 1800/GSM 1900	26	
	GPRS, 4 TX	GSM 850/E-GSM 900	33	
		GSM 1800/GSM 1900	30	
	EDGE, 4 TX	GSM 850/E-GSM 900	27	
		GSM 1800/GSM 1900	26	
	RF Power @ ARP with 500hm Load, (ROPR = 1)	GPRS, 1 TX	GSM 850/E-GSM 900	33
			GSM 1800/GSM 1900	30
		EDGE, 1 TX	GSM 850/E-GSM 900	27
			GSM 1800/GSM 1900	26
GPRS, 2 TX		GSM 850/E-GSM 900	33	
		GSM 1800/GSM 1900	30	
EDGE, 2 TX		GSM 850/E-GSM 900	27	
		GSM 1800/GSM 1900	26	
GPRS, 3 TX		GSM 850/E-GSM 900	33	
		GSM 1800/GSM 1900	30	

	EDGE, 3 TX	GSM 850/E-GSM 900	27
		GSM 1800/GSM 1900	26
	GPRS, 4 TX	GSM 850/E-GSM 900	31
		GSM 1800/GSM 1900	28
	EDGE, 4 TX	GSM 850/E-GSM 900	27
		GSM 1800/GSM 1900	26
RF Power @ ARP with 500hm Load, (ROPR = 2)	GPRS, 1 TX	GSM 850/E-GSM 900	33
		GSM 1800/GSM 1900	30
	EDGE, 1 TX	GSM 850/E-GSM 900	27
		GSM 1800/GSM 1900	26
	GPRS, 2 TX	GSM 850/E-GSM 900	33
		GSM 1800/GSM 1900	20
	EDGE, 2 TX	GSM 850/E-GSM 900	27
		GSM 1800/GSM 1900	26
	GPRS, 3 TX	GSM 850/E-GSM 900	33
		GSM 1800/GSM 1900	30
	EDGE, 3 TX	GSM 850/E-GSM 900	27
		GSM 1800/GSM 1900	26
	GPRS, 4 TX	GSM 850/E-GSM 900	29
		GSM 1800/GSM 1900	26
	EDGE, 4 TX	GSM 850/E-GSM 900	27
		GSM 1800/GSM 1900	26

RF Power @ ARP with 500hm Load, (ROPR = 3)	GPRS, 1 TX	GSM 850/E-GSM 900	33
		GSM 1800/GSM 1900	30
	EDGE, 1 TX	GSM 850/E-GSM 900	27
		GSM 1800/GSM 1900	26
	GPRS, 2 TX	GSM 850/E-GSM 900	33
		GSM 1800/GSM 1900	30
	EDGE, 2 TX	GSM 850/E-GSM 900	27
		GSM 1800/GSM 1900	26
	GPRS, 3 TX	GSM 850/E-GSM 900	33
		GSM 1800/GSM 1900	30
	EDGE, 3 TX	GSM 850/E-GSM 900	27
		GSM 1800/GSM 1900	26
	GPRS, 4 TX	GSM 850/E-GSM 900	27
		GSM 1800/GSM 1900	24
	EDGE, 4 TX	GSM 850/E-GSM 900	27
		GSM 1800/GSM 1900	24
RF Power @ ARP with 500hm Load, (ROPR = 4, i.e. maximum reduction)	GPRS, 1 TX	GSM 850/E-GSM 900	33
		GSM 1800/GSM 1900	30
	EDGE, 1 TX	GSM 850/E-GSM 900	27
		GSM 1800/GSM 1900	26
	GPRS, 2 TX	GSM 850/E-GSM 900	30
		GSM 1800/GSM 1900	27



	EDGE, 2 TX	GSM 850/E-GSM 900		24
		GSM 1800/GSM 1900		23
	GPRS, 3 TX	GSM 850/E-GSM 900		28.2
		GSM 1800/GSM 1900		25.2
	EDGE, 3 TX	GSM 850/E-GSM 900		22.2
		GSM 1800/GSM 1900		21.2
	GPRS, 4 TX	GSM 850/E-GSM 900		27
		GSM 1800/GSM 1900		24
	EDGE, 4 TX	GSM 850/E-GSM 900		21
		GSM 1800/GSM 1900		20

The table below briefly summarizes the RF Antenna interface LTE (dBm).

PARAMETER		CONDITIONS	MIN	TYP
LTE Connectivity		Band 1, 3, 8, 20		
Receiver Input Sensitivity @ARP (ch. bandwidth 5MHz)		LTE 800 Band 20		-97
		LTE 900 Band 8		-97
		LTE 1800 Band 3		-97
		LTE 2100 Band 1		-100
RF Power @ ARP with 50Ω Load (Dual Antenna; power supply: 3.8V; temperature 25 °C)		LTE 800 Band 20		23
		LTE 900 Band 8		23
		LTE 1800 Band 3		23
		LTE 2100 Band 1		23
GPRS Coding Schemes		Class 12, CS1 to CS4		
EGPRS		Class 12, MCS1 to MCS9		
GSM Class		Small MS		
Static Receiver Input Sensitivity @ ARP		GSM 900	-102	-109
		GSM 1800	-102	-108
RF Power @ ARP with 50Ω Load	GSM	GSM 900		32.5
		GSM 1800		29.5

RF Power @ ARP with 50Ω Load, (ROPR = 0, i.e. no reduction)	GPRS, 1 TX	GSM 900		32.5
		GSM 1800		29.5
	EDGE, 1 TX	GSM 900		27
		GSM 1800		26
	GPRS, 2 TX	GSM 900		32.5
		GSM 1800		29.5
	EDGE, 2 TX	GSM 900		27
		GSM 1800		26
	GPRS, 3 TX	GSM 900		32.5
		GSM 1800		29.5
	EDGE, 3 TX	GSM 900		27
		GSM 1800		26
	GPRS, 4 TX	GSM 900		32.5
		GSM 1800		29.5
	EDGE, 4 TX	GSM 900		27
		GSM 1800		26
RF Power @ ARP with 50Ω Load, (ROPR = 1)	GPRS, 1 TX	GSM 900		32.5
		GSM 1800		29.5
	EDGE, 1 TX	GSM 900		27
		GSM 1800		26
	GPRS, 2 TX	GSM 900		32.5
		GSM 1800		29.5

	EDGE, 2 TX	GSM 900	27	
		GSM 1800	26	
	GPRS, 3 TX	GSM 900	31.5	
		GSM 1800	28.5	
	EDGE, 3 TX	GSM 900	27	
		GSM 1800	26	
	GPRS, 4 TX	GSM 900	30.5	
		GSM 1800	27.5	
	EDGE, 4 TX	GSM 900	27	
		GSM 1800	26	
	RF Power @ ARP with 50Ω Load, (ROPR = 2)	GPRS, 1 TX	GSM 900	32.5
			GSM 1800	29.5
EDGE, 1 TX		GSM 900	27	
		GSM 1800	26	
GPRS, 2 TX		GSM 900	30.5	
		GSM 1800	27.5	
EDGE, 2 TX		GSM 900	27	
		GSM 1800	26	
GPRS, 3 TX		GSM 900	29.5	
		GSM 1800	26.5	
EDGE, 3 TX		GSM 900	27	
		GSM 1800	26	

	GPRS, 4 TX	GSM 900	28.5
		GSM 1800	25.5
	EDGE, 4 TX	GSM 900	27
		GSM 1800	26
RF Power @ ARP with 50Ω Load, (ROPR = 3)	GPRS, 1 TX	GSM 900	32.5
		GSM 1800	29.5
	EDGE, 1 TX	GSM 900	27
		GSM 1800	26
	GPRS, 2 TX	GSM 900	29.5
		GSM 1800	26.5
	EDGE, 2 TX	GSM 900	27
		GSM 1800	26
	GPRS, 3 TX	GSM 900	27.5
		GSM 1800	24.5
	EDGE, 3 TX	GSM 900	27
		GSM 1800	26
	GPRS, 4 TX	GSM 900	26.5
		GSM 1800	23.5
	EDGE, 4 TX	GSM 900	27
		GSM 1800	26

RF Power @ ARP with 50Ω Load, (ROPR = 4, i.e. maximum reduction)	GPRS, 1 TX	GSM 900		32.5
		GSM 1800		29.5
	EDGE, 1 TX	GSM 900		27
		GSM 1800		26
	GPRS, 2 TX	GSM 900		29.5
		GSM 1800		26.5
	EDGE, 2 TX	GSM 900		24
		GSM 1800		23
	GPRS, 3 TX	GSM 900		27.5
		GSM 1800		24.5
	EDGE, 3 TX	GSM 900		22
		GSM 1800		21
	GPRS, 4 TX	GSM 900		26.5
		GSM 1800		23.5
	EDGE, 4 TX	GSM 900		21
		GSM 1800		20

## 4.5 SIM card

The MTX-T supports an external SIM card through the integrated SIM holder. Both 3V and 1.8V SIM technology is supported. Older 5V SIM technology is not supported.

## ● 5. Precautions

MTX-T as a standalone item is designed for indoor use only. For outdoor use it must be integrated into a weatherproof enclosure. Do not exceed the environmental and electrical limits as specified in Technical Data.

## ● 6. Block Diagram

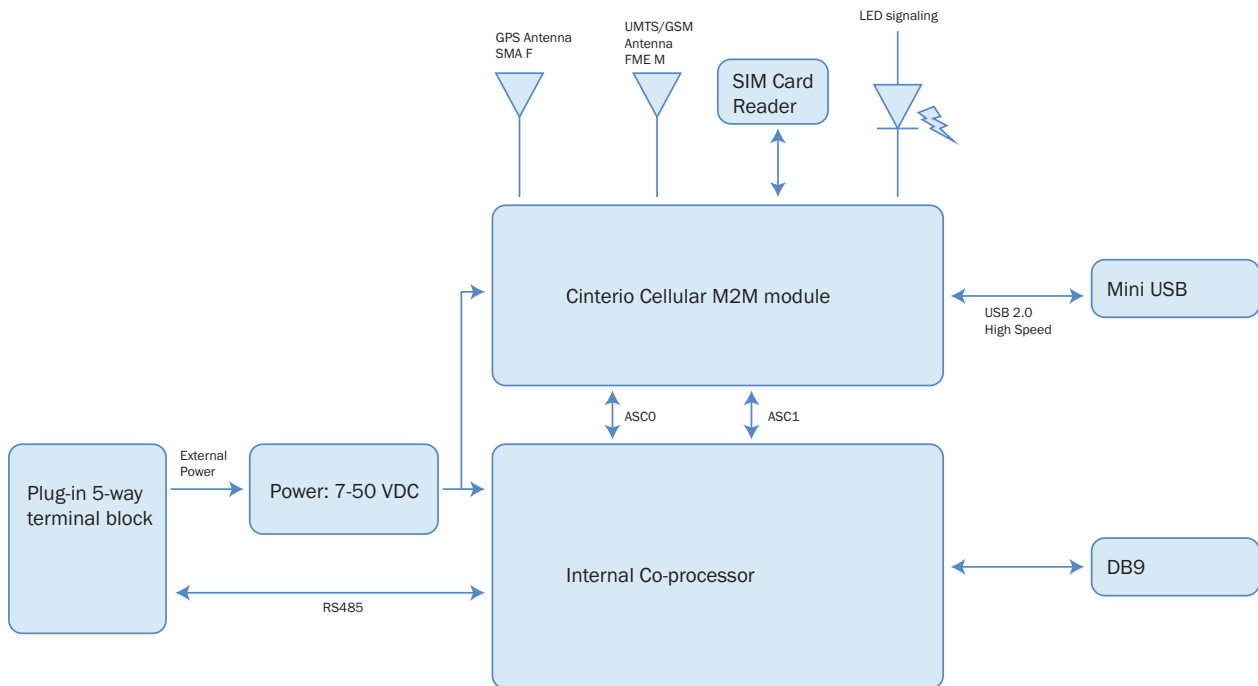



## ● 7. Hardware Revisions

HARDWARE REVISION	STARTING PRODUCTION DATE	CHANGES
1.01	2019/02	Initial version

# MECHANICAL DESCRIPTION

## ● 1. Overview

### 1.1 Models with 5-way plug-in 5.00mm pitch terminal block

The pictures below show the mechanical design of the unit along with the positions of the different connectors and mounting holes. The device case is made of durable PC/ABS plastic.

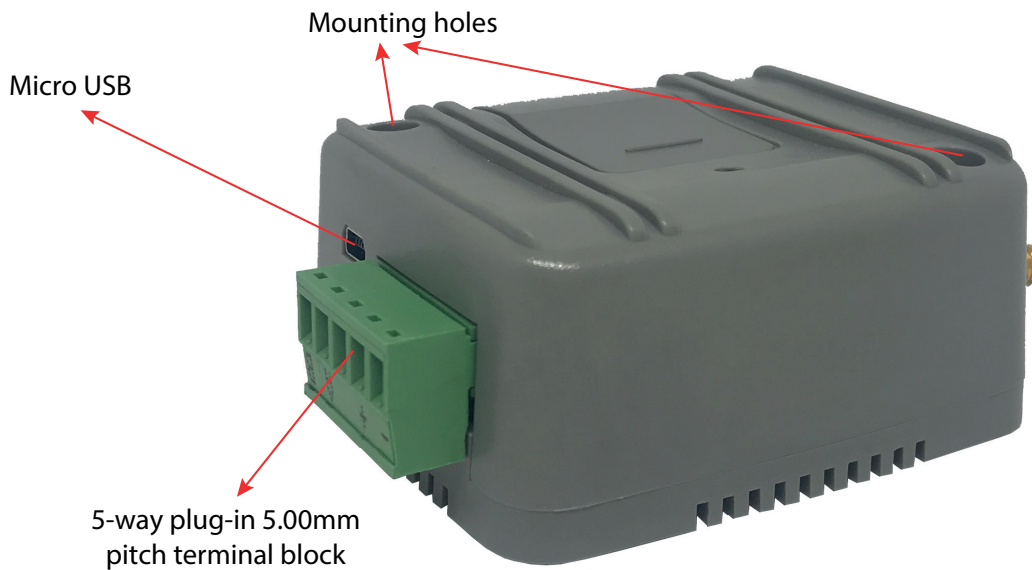
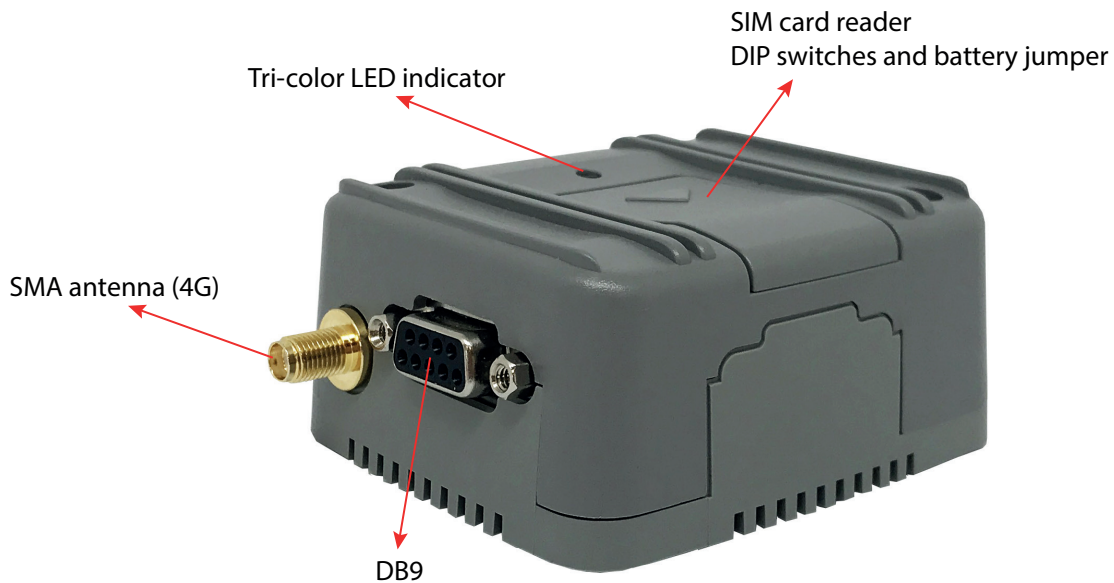

## ● 2. Dimensions (mm)

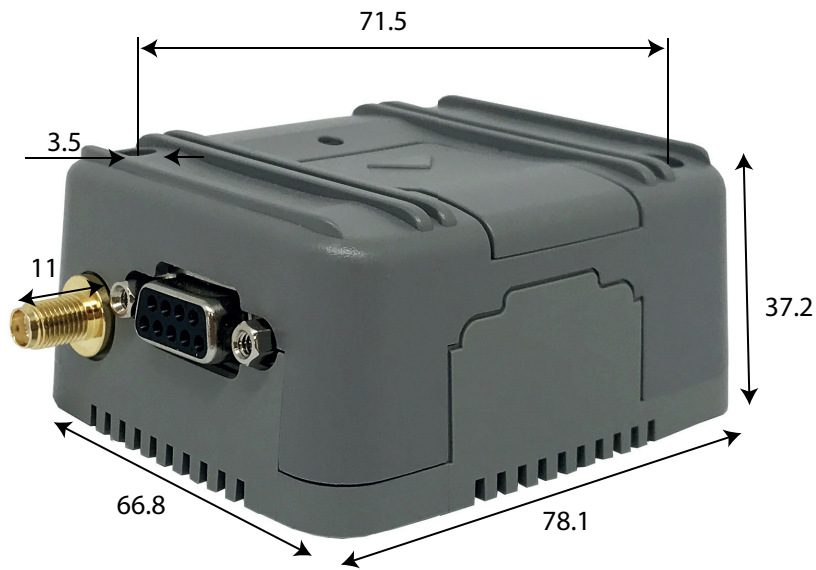

Packaging:

Box 15 units: 37cm x 32cm x 4cm, 1.211Kg

Box 150 units (contains 10 boxes of 15 units): 38cm x 33cm x 48cm, 20Kg



# ELECTRICAL AND ENVIRONMENTAL CHARACTERISTICS

## ● 1. Electrical specifications

### 1.1 Power supply

ABSOLUTE MAXIMUM RATINGS						
Symbol	Parameter	Conditions	Min	Max	Unit	
VIN	Supply voltage		-0.3	65	V	

CHARACTERISTICS						
Symbol	Parameter	Conditions	Min	Typ	Max	Unit
VIN	Supply voltage		7		50	V
IIN	Supply current		-	*	-	A
$\eta$	Efficiency	VIN=24V, IOU=1.5A		87		%
f <sub>o</sub>	Switching frequency			500		kHz

\*See section Introduction 7.3 (Power Consumption)

## 1.2 RS232 interface

ABSOLUTE MAXIMUM RATINGS					
Symbol	Parameter	Conditions	Min	Max	Unit
Vi	Input voltage range	Drivers	-0.3	65	V
		Receivers	-25	25	V
Vo	Output voltage range	Drivers	-13.2	13.2	V
		Receivers	-0.3	5	V
	Electrostatic discharge	Human body model		2	kV

CHARACTERISTICS						
Symbol	Parameter	Conditions	Min	Typ	Max	Unit
VOH	Driver high-level output voltage	RL=3kΩ to GND	5	5.4		V
VOL	Driver low-level output voltage	RL=3kΩ to GND	-5	5.4		V
ro	Driver output resistance	VIN = 0V	300	10M		Ω
VIT+	Receiver positive-going input threshold voltage			1.5	2.4	V
VIT-	Receiver negative-going input threshold voltage		0.6	1.2		V
Vhys	Receiver input hysteresis (VIT+ - VIT-)			0.3		V
ri	Receiver input resistance	Input voltage ±3 to ±25V	3	5	7	kΩ

### 1.3 RS485 interface

ABSOLUTE MAXIMUM RATINGS						
Symbol	Parameter	Conditions	Min	Max	Unit	
$V_I$	Voltage input range, transient pulse, A & B, through $100\ \Omega$			$\pm 50$	V	
$I_O$	Receiver output current			$\pm 11$	mA	
	Electrostatic discharge	Human body model		$\pm 16$	kV	
		Charged-device model		$\pm 1$	kV	

CHARACTERISTICS						
Sym	Parameter	Conditions	Min	Typ	Max	Ut
$ V_{OD} $	Driver differential output voltage	$I_O = 0$	2		3	V
		$R_L = 54\text{k}\Omega$	-5	-5.4		V
$C_{(OD)}$	Driver differential output capacitance	$V_{OD} = 0.4\sin(4\pi f t) + 0.5\text{V}$		16		pF
$I_{OS}$	Driver short-circuit output current				250	mA
$V_{IT+}$	Receiver positive-going input threshold voltage	$I_O = -8\text{mA}$		-0.065	-0.01	V
$V_{IT-}$	Receiver negative-going input threshold voltage	$I_O = 8\text{mA}$	-0.2	-0.1		V
$V_{hys}$	Receiver input hysteresis ( $V_{IT+} - V_{IT-}$ )			35		mV
$C_{(ID)}$	Receiver differential input capacitance	$V_{OD} = 0.4\sin(4\pi f t) + 0.5\text{V}$		15		pF

## 1.4 Digital input

ABSOLUTE MAXIMUM RATINGS						
Symbol	Parameter	Conditions	Min	Max	Unit	
V <sub>I</sub>	Input voltage range		-12	40	V	

CHARACTERISTICS						
Symbol	Parameter	Conditions	Min	Typ	Max	Unit
V <sub>IH</sub>	High-level input voltage		2.0			V
V <sub>IL</sub>	Low-level input voltage				0.9	V

## ● 2. Operating Temperatures

Please note that the modem's lifetime, i.e., the MTTF (mean time to failure) may be reduced if operated outside the extended temperature range.

PARAMETER	MIN	TYP	MAX	UNIT
Normal operation	-30	25	85	°C
Extended operation	-40		90	°C
Automatic shutdown	<-40		>90	°C

1. Extended operation allows normal mode speech calls or data transmissions for a limited time until the automatic thermal shutdown mode takes effect. Within the extended temperature range (outside the operating temperature range) the specified electrical characteristics may be increased or decreased.
2. Due to uncertainty in temperature measurement, a tolerance of  $\pm 3^{\circ}\text{C}$  on the stated shutdown thresholds may occur.

Note that within the specified operating temperature ranges the unit temperature may vary to a great extent depending on the operating mode, used frequency band, radio output power and current supply voltage.



### ● 3. Storage Conditions

The conditions stated below are only valid for modems in their original packed state in weather protected, non-temperature-controlled storage locations. Normal storage time under these conditions is a maximum of 12 months. The units will be delivered in a packaging that meets the requirements according “IPD/ JEDEC J-STD-033B.1” for Low Temperature Carriers.

TYPE	CONDITION	UNIT	REFERENCE
Air temperature: Low High	-30 75	°C	ETS 300 019-2-1: T1.2, IEC 60068-2-1 Ab ETS 300 019-2-1: T1.2, IEC 60068-2-2 Db
Relative humidity: Low High Cond.	10 90 at 30°C 90-100 at 30°C	%	- ETS 300 019-2-1: T1.2, IEC 60068-2-56 Cb ETS 300 019-2-1: T1.2, IEC 60068-2-30 Db
Air pressure: Low High	70 106	kPa	IEC TR 60271-3-1:1K4 IEC TR 60271-3-1:1K4
Movement of air	1.0	m/s	IEC TR 60271-3-1:1K4
Water: rain, dripping, icing and frosting	Not allowed	-	-
Radiation: Solar Heat	1120 600	W/m <sup>2</sup>	ETS 300 019-2-1: T1.2, IEC 60068-2-2Bb ETS 300 019-2-1: T1.2, IEC 60068-2-2Bb
Chemically active subs.	Not recomm.		IEC TR 60271-3-1:1C1L
Mechanically active subs.	Not recomm.		IEC TR 60271-3-1:1S1
Sinusoidal vibration: Displacement Acceleration Frequency range	1.5 5 2-9 9-200	mm m/s <sup>2</sup> Hz	IEC TR 60271-3-1:1M2
Shocks: Shock spectrum Duration Acceleration	semi-sinusoidal 1 50	ms m/s <sup>2</sup>	IEC 60068-2-27 Ea

# INTERFACE DESCRIPTION

All electrical connections to the modem are protected in compliance with the standard air and contact Electrostatic Discharge (ESD).

The modem family uses the following industry standard connectors:

- USB mini connector
- DB9 female (main RS232 port)
- 5-way plug-in 5.00mm pitch terminal block (power supply, RS485 bus and digital input)
- SIM card reader
- SMA female coaxial jack (GPS/GNSS antenna connector) or other RF options

## ● 1. Power Supply Connector

Depending on the specific modem you are using, you will dispose of one of the connectors described in the sections below. Please read them carefully.

### 1.1 5-way plug-in 5.00mm pitch terminal block

A 5 way plug-in terminal block connector shared with RS485 bus, as shown and described below, supplies D.C. power to the modem.

The supply voltage, VCC, required by the modem is in the range of 7 to 50VDC. We recommend a 12VDC power supply. The power supply has to be a single voltage source capable of providing a peak during an active transmission. The uplink burst causes strong ripples (drop) on the power lines.

By default, the MTX-T will automatically switch on when power supply is applied between PIN 4 and PIN 5.



PIN	SIGNAL	DIRECTION	LIMITS	DESCRIPTION
1	-RxB	I/O		RS485 B signal (see section Interface Description 5 (RS485 bus) for details)
2	+RxA	I/O		RS485 A signal (see section Interface Description 5 (RS485 bus) for details)
3	Digital In	Input	0-VIN	Digital input
4	VIN	Input	7-50VDC	Positive power input
5	GND	Input		Negative power (ground)

## ● 2. Micro USB Connector

The MTX-T supports a USB 2.0 High Speed (480Mbit/s) device interface. The USB interface is primarily intended for use as a command and data interface and for downloading firmware. The USB I/O pins are capable of driving the signal at a minimum of 3.0V. They are 5V I/O compliant.

The USB port has different functions depending on whether Java is running or not. With Java, the lines may be used for debugging purposes. If Java is not used, the USB interface is available as a command and data interface and for downloading firmware.

To properly connect the module's USB interface to the host, a USB 2.0 compatible connector is required. Furthermore, the USB modem driver which is delivered with MTX-T must be installed as described below.

The USB host is responsible for supplying power across the VUSB\_IN line to the module's USB interface. This is because MTX-T is designed as a self-powered device compliant with the "Universal Serial Bus Specification Revision 2.0".

The MTX-T cannot be powered by a USB port. Only modems that have a mounted an internal Li-Po battery (B) can operate with USB power voltage.

There are drivers available for Windows and Linux environment applications. Visit the MTX-T web page at [www.mtxm2m.com](http://www.mtxm2m.com).

## ● 3. DB9 Connector: I/O port

### 3.1 RS232

The MTX-T modem is designed to be used as a DCE (data circuit-terminating equipment). Based on the conventions for DCE-DTE connections, it communicates with the customer application (DTE- data terminating equipment) using the following signals:

- Port TxD @ application sends data to MTX-3G-T Terminal's TD
- Port RxD @ application receives data from MTX-3G-T Terminal's RD

The RS232 interface is implemented as a serial asynchronous transmitter and receiver conforming to ITU-T V.24 Interchange Circuits DCE. It is configured for 8 data bits, no parity and 1 stop bit and can be operated at fixed bit rates from 300bps to 460.8kbps.

The electrical characteristics of the serial port signals are shown below:

PIN	SIGNAL	DIRECTION	DESCRIPTION
2	RD 0	Output	Received data
3	TD 0	Input	Transmitted data
5	GND	-	Ground connection
7	RTS 0	Input	Request to send
8	CTS 0	Output	Clear to send
9	VEXT	Output	Output voltage reference (4V)

Features (when connected to ASC0 or ASC1)

- Includes data lines TD1 and RD1 (2-wire/4-wire)
- Includes the status lines RTS1 and CTS1 and supports hardware flow control (4-wire only)
- The default configuration is 8 data bits, no parity and 1 stop bit. The setting can be changed using the AT command AT+ICF and, if required, AT^STPB
- Can be operated at fixed bit rates from 1200 bps to 921600 bps. Autobauding is not supported
- **The default serial speed for MTX-T is 115200bps**

### 3.2 Digital input

The MTX-T has a digital input located in the 5-way terminal block. Please refer to section Interface Description 4.1 (Connector pinout) to view the exact location of the signal I/O.

The electrical equivalent circuits of the counter input is shown in following figure:

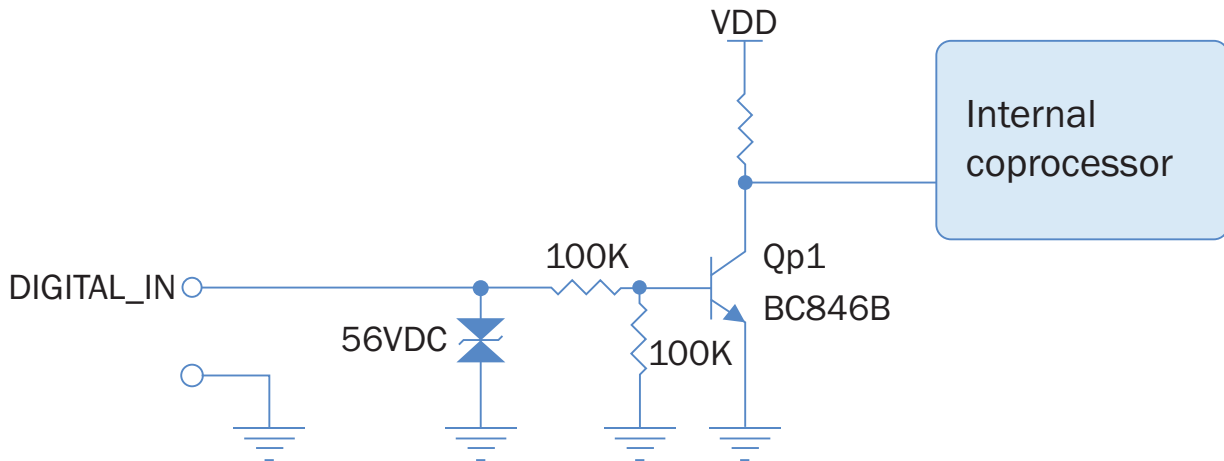

To know how to use this counter please read the MTX-T Family Software Manual.

## ● 4. RS485 bus

The STD models have a terminal block with a 5-way connector shared with the Power Supply section, as shown and described below, used to implement the RS485 interface.

It meets or exceeds the requirements of ANSI TIA/EIA-485-A.

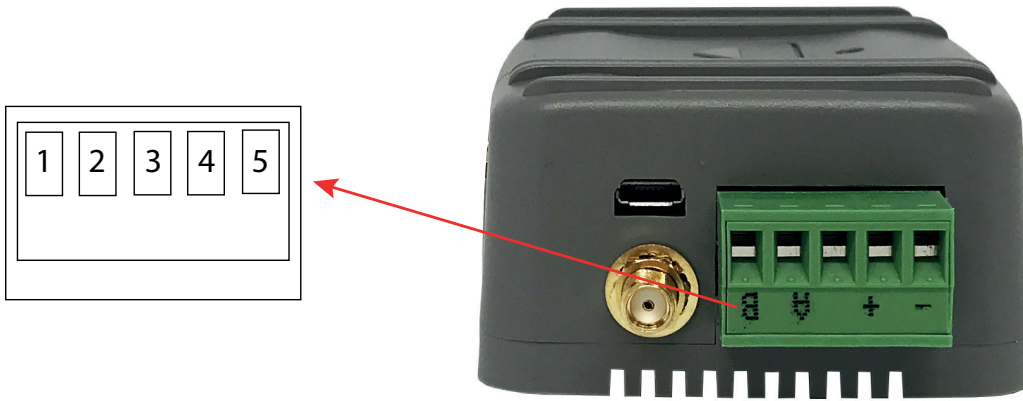

PIN	SIGNAL	DIRECTION	LIMITS	DESCRIPTION
1	-RxB	I/O		RS485 B signal
2	+RxA	I/O		RS485 A signal
3	Digital In	Input	0-VIN	Digital input
4	VIN	Input	6.5-40VDC	Positive power input
5	GND	Input		Negative power (ground)

## ● 5. GSM/GPRS/UMTS ANTenna Connector

The antenna connector allows radio frequency (RF) transmission signals between the modem and an external customer-supplied antenna. The modem is fitted with a 50Ω, FME male coaxial jack.

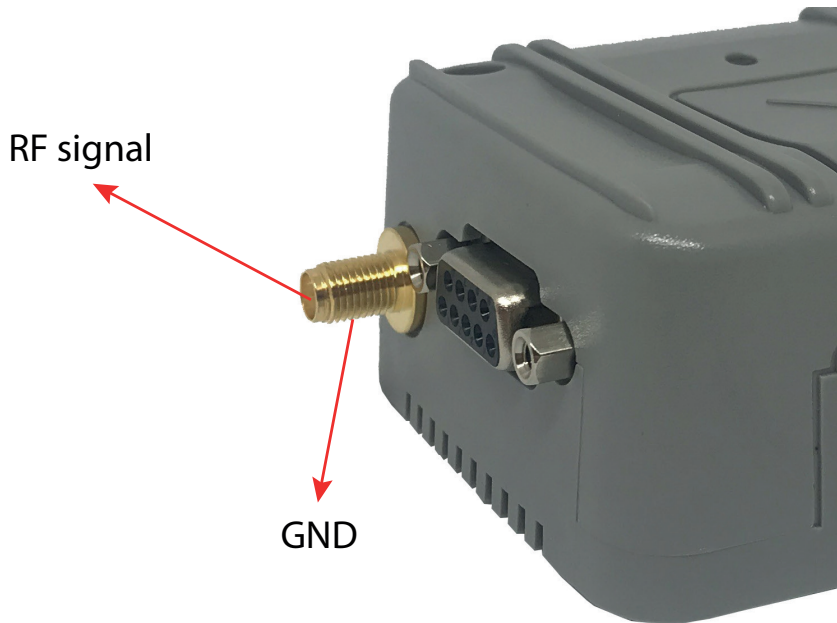

The external antenna must be matched properly to achieve the best performance regarding radiated power, DC-power consumption, modulation accuracy and harmonic suppression.



## ● 6. SIM Card Reader

The MTX-T modem is fitted with a SIM card reader designed for 1.8V and 3V SIM cards. It is the flip-up type which is lockable in the horizontal position and is accessed through a removable panel as shown below.



The card holder is a five wire interface according to GSM 11.11. It has a SIM card detector switch to detect whether or not the SIM card drawer is inserted.

Removing and inserting the SIM card during operation requires the software to be reinitialized. Therefore, after reinserting the SIM card it is necessary to restart the MTX-3G-T modem.

The full operation of the MTX-T relies on a SIM card being inserted. Some MTX-T functionality may be lost if you try to operate the control modem without a SIM card.

## ● 7. Real Time Clock

The GSM module attached to MTX-T modems contains a real time clock (RTC) to maintain accurate timekeeping and to enable you to “time stamp” messages.

This RTC is supplied by a separate voltage regulator which is also active when the MTX-T is in power down mode and the power supply VIN is available. An alarm function is provided that allows the MTX-T to wake up in Airplane mode without logging onto the GSM/UMTS network.

The MTX-T modems also accommodate an independent super-cap inside to maintain the date and time of the RTC when the power supply is disconnected. This super-cap will be charged when power supply is present again.

## ● 8. GPS

The MTX-T ordered with GPS option (2G/GPS or 3G/GPS) has an internal GPS receiver which offers the full performance of GPS technology. The GPS receiver continuously tracks all satellites in view, thus providing accurate satellite positioning data.

### 8.1 GPS antenna connector

The antenna connector allows for the transmission of radio frequency (RF) signals between the modem and an external customer-supplied antenna. The modem is fitted with a 50Ω, SMA F coaxial jack.

It is possible to connect active or passive GPS antennas. In either case they must have 50 Ohm impedance.



### 8.2 GPS application interface

The MTX-T has an internal GPS receiver which offers the full performance of GPS technology. The GPS receiver continuously tracks all satellites in view, thus providing accurate satellite positioning data.

The GPS receiver supports the NMEA protocol via serial port (RS232/RS485) and USB interface. It is able to recognize input messages from any of these protocols (e.g., GGA, RMC GSA, GSV) and respond to them accordingly. Input messages can be arbitrarily mixed.

The NMEA protocol is an industry standard protocol developed for marine electronics. It was originally designed to allow data exchange between various sensors and navigation equipment aboard ships. Nowadays, it is a de-facto standard for GPS receiver data output. For more information on the NMEA Standard please refer to [www.nmea.org](http://www.nmea.org).

### 8.3 GPS antenna interface characteristics

Depending on the receiver's knowledge of last position, current time and ephemeris data, the receiver's startup time (TTFF) may vary: if the receiver has no knowledge of its last position or time, a startup takes considerably longer than if the receiver has still knowledge of its last position, time and almanac or has still access to valid ephemeris data and the precise time.

PARAMETER	CONDITIONS	MIN	TYP	MAX	UNIT
Frequency		1575	1575.42	1585	MHz
Tracking Sensitivity	Open sky		-167		dBm
	Active antenna or LNA Passive antenna		-162		
Acquisition Sensitivity	Open sky		-150		dBm
	Active antenna or LNA Passive antenna		-145		
Time-to-First-Fix (TTFF)	Hot (average at -140dBm)		<2		s
	Warm (average at -140dBm)		<35		s
	Cold (average at -140dBm)		<46		s

## ● 9. Firmware Updates

It is possible and sometimes necessary to update the MTX-T firmware. Updates must be carried out by an approved technician. Please contact [iotsupport@mtx2m.com](mailto:iotsupport@mtx2m.com) for details regarding Service/Programming.

# OPERATION

## ● 1. Switching on the modem. New “Automatic restart after shutdown” feature

There is no special way to turn the modem on: just apply power to the VIN terminal via a power connector (see section interface Description 1 (Power Supply Connector)). The modem will be fully operational after 4 to 9 seconds. Logging onto a network may take longer than this and is out of the modem’s control.

The Automatic Restart after Shutdown feature is enabled as part of the default factory settings, and can’t be disabled. This means that if/when the modem has to be switched off, due to a critical power supply, the modem will restart itself within a few seconds. This feature allows an application to be switched on all the time and also allows it to restart itself.

## ● 2. Status LEDs

The MTX-T modem family has a tricolor status LED (blue, green and red).

The green color LED is handled automatically by the modem and indicates its different operating modes, as shown in table below. The LED mode configuration is set by the AT^SLED command.

TERMINAL STATUS	<mode>=1	<mode>=2 <flash>=def.	<mode>=2 <flash>=user defined
<ul style="list-style-type: none"> <li>• GSM CS data call in progress/established</li> <li>• GSM voice call in progress/established</li> <li>• UMTS voice call in progress/established</li> <li>• UMTS CS data call in progress</li> </ul>	Permanently ON	10ms ON 990ms OFF	<flash> ms ON 990 ms OFF
<ul style="list-style-type: none"> <li>• GSM PS data transfer</li> <li>• UMTS data transfer</li> </ul>	Permanently ON	10ms ON 1990ms OFF	<flash> ms ON 1990 ms OFF
<ul style="list-style-type: none"> <li>• ME registered to a network. No call, no data transfer</li> </ul>	Permanently ON	10ms ON 1990ms OFF	<flash> ms ON 3990 ms OFF
<ul style="list-style-type: none"> <li>• Limited Network Service (e.g. no SIM, no PIN or during network search)</li> </ul>	500ms ON 500ms OFF	10ms ON 990ms OFF	<flash> ms ON 990 ms OFF

The blue and red color LEDs can be controlled independently by the user. This allows to define the functionality of this LED. You can configure both LEDs in the following way:

- Permanently OFF
- Permanently ON
- Fast blink: 60ms ON, 60ms OFF
- Medium blink: 500ms ON, 500ms OFF
- Slow blink: 1000ms ON, 1000ms OFF
- Pulse: 100ms ON, 900ms OFF

To learn how to use these LEDs please read the MTX-T Family Software Manual.

# AT COMMAND INTERPRETER

After a successful installation of the driver package, the physical USB interface of the modem is represented in the operating system by two virtual interfaces, each assigned to a virtual COM port of its own:

## Modem interface:

This interface is referred to as “Modem” if queried using the AT^SQPORT command. In the quick reference tables it is named USB0-MDM.

The Modem interface is intended particularly for data transmission (UMTS or GPRS).

All URCs are normally issued on the Application interface. URCs related to data calls (RING, NO CARRIER) as well as the “^SYSSTART” URC are issued on the Modem interface.

## Application interface:

This interface is referred to as “Application” if queried using the AT^SQPORT command. In the quick reference tables it is named USB0-APP.

The Application interface is designed especially for controlling the IoT, i.e. for entering AT commands, receiving URCs, or sending and receiving short messages. It cannot be used as a data interface for UMTS, or GPRS.

Please note that URCs are normally indicated only on this interface, no matter whether the Modem interface or the Application interface was used to send the AT commands to activate their presentation. This URC management scheme is the default configuration recommended for a typical MTX-T application.

Bear in mind that the Modem interface and the Application interface are handled by the same AT command interpreter.

As a result, AT commands entered on both interfaces are not executed in parallel but sequentially, one after the other. So, an AT command issued on one interface will be buffered on this interface to be executed after the other interface has completed processing earlier AT command(s).

When a data connection is established over the Modem interface, the Application interface can be used simultaneously for any control functions. This eliminates the need for the user to enter AT commands, such as +++ and AT0, as well as switching back and forth between command and online mode when working on one interface only.



# EMBEDDED APPLICATIONS

The MTX-T can embed an internal application written in popular Java language. Java technology and several peripheral interfaces on the modem allow you to easily integrate your application. This way, the customer application can be reduced because all the resources (Microcontroller, Flash & RAM memory and all kind of I/O and bus peripheral) can be used by the customer. This solution saves the external intelligence with all the associate costs and also saves space and power consumption.

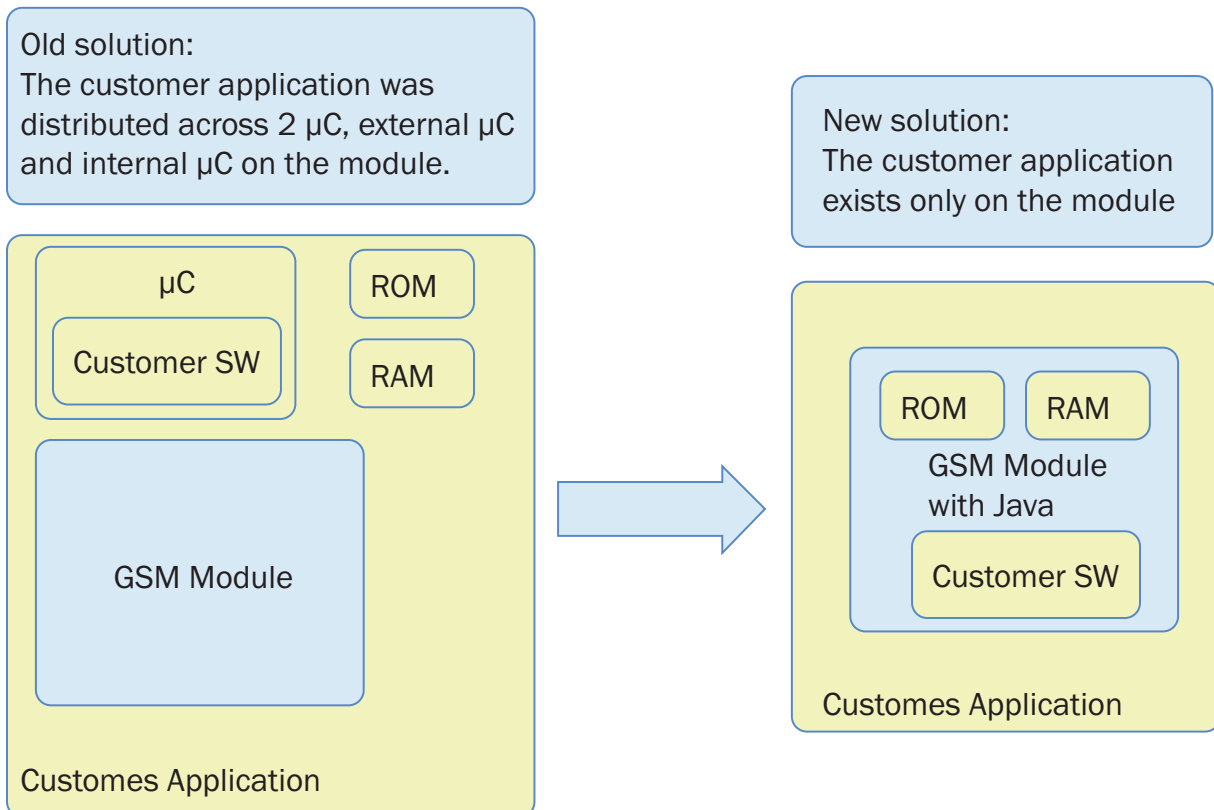

## Features:

- Oracle Java ME Embedded 3.2 Compliant to CLDC 1.1 HI (JSR139) and IMP-NG (JSR228) Java standards.
- Capable of running multiple MIDlets in parallel with inter-MIDlet communication.
- Additional Java standard APIs:
  - JSR75 (FileConnection)
  - JSR177 (CRYPTO)
  - JSR280 (XML)

- Additional Java proprietary APIs:
  - AT Command API
  - Watchdog API
- Additional accessible periphery for Java applications
  - I/O pins- I2C Interface, SPI interface, DAC,ADC
  - Serial interfaces (API): (ASCO, ASC1, USB\*) can be used to connect external devices
- Memory space for Java programs:
  - Flash File System: around 8 MB
  - RAM: around 6MB
  - Just-in-Time Compiler execution optimization
- Over-the-air update
  - Application SW: OTAP
  - Firmware: FOTA (OMA compliant)

Ask [gsm-support@matrix.es](mailto:gsm-support@matrix.es) for application notes and a free SDK (Software Development Kit); we will provide Matrix FTP server to download it.

## ● 1. MTX-Tunnel Software Application

If you are not a Java expert and you do not have experts on hand in your company, we have a readily compiled Java code which fits into 99% of M2M applications: MTX-Tunnel. This is optional and must be ordered separately.

MTX-Tunnel is an application running in the GSM/GPRS/UMTS modems and is based on the EHS6 module which is designed for communicating with remote devices that have RS232 ports.

Frequently, remote meters, network switches, routers or other devices need to connect to the network, but they only have an RS232 port and the only possible way to reach them is using the GSM/GPRS Network. MTX-Tunnel is ready-to-go solution for such cases.

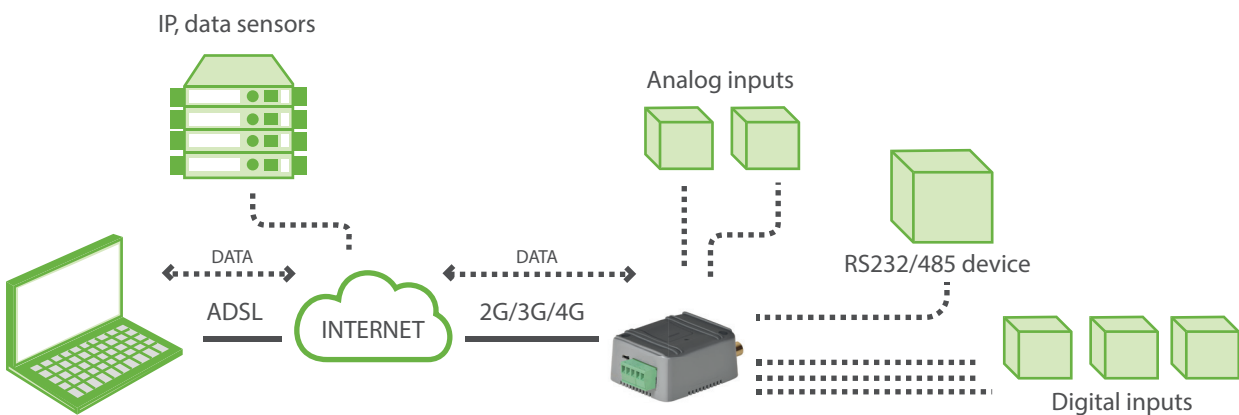

It acts as a transparent RS232 port. You will see your remote devices as if they were directly connected to the computer.

MTX-Tunnel V8 has extra features like webserver, SMS telemetry, Telnet, DNS, modbus and gateway RF.

```
C:\> Telnet mtxtunnel.dyndns.org
#login:admin
#password:1234
Welcome to MTXTunnel
#AT
AT
OK
#ATI
ATI
Cinterion
TC65i
REVISION 01.100

OK
#AT+CSQ
AT+CSQ
+CSQ: 27,99

OK
#_
```

## Features:

- GPRS-SERIAL Tunnel
  - TCP Client
  - TCP Server
  - UDP Client / Server
- GPRS connection modes:
  - Permanent mode
  - Upon request (SMS or missed calls, authorized or blocked phone numbers)
  - Change on an input digital level
  - An analog input is out of the selected level window (MIN, MAX)
  - Serial data present on RS232/RS485 port
  - Scheduled date/hour timing
- WebServer
- Telnet
- SMS Alarms and Output control
- IPs dynamic resolution:
  - DynDNS
  - Private DNS
  - SMS
- SSL Security
- Firewall IP
- User API
- Telemetry (GPIOs and GPS)
- Serial RS232/485 – HTTP Tunnel
- Serial RS232/485 – SMS Tunnel
- Timing synchronization
- ModBus
- RF Gateway

# SAFETY AND PRODUCT CARE

Please read the information in this section and the information in “Installation of the Modem”, before starting your integration work.

## ● 1. Safety Instructions

PLEASE READ THESE SAFETY INSTRUCTIONS AND KEEP A COPY OF THEM.

- Always ensure that use of the modem is permitted. The modem may present a hazard if used in proximity to personal electronic medical devices. As a rule, the modem must not be used in hospitals, airports or planes
- Never use the modem at a gas station, refueling point, blasting area or in any other environment where explosives may be present
- Operating the modem close to other electronic devices, such as antennas, television sets, and radios may cause electromagnetic interference
- This product is intended to be used with the antenna or other radiating element at least 20cm away from any part of the human body. In applications where this rule cannot be applied, the application designer is responsible for providing the SAR measurement test report and declaration
- You are responsible for observing your country’s safety standards, and where applicable, the relevant wiring rules

## ● 2. General Precautions

The MTX-T modem as a standalone item is designed for indoor use only. For outdoor use it must be integrated into a weatherproof enclosure. Do not exceed the environmental and electrical limits as specified in “Technical Data.”

- Avoid exposing the modem to lighted cigarettes, naked flames or to extreme hot or cold temperatures
- Never try to dismantle the modem yourself. There are no components inside the modem that can be serviced by the user. If you attempt to dismantle the modem, you may invalidate the warranty
- The MTX-T modem must not be installed nor located in areas where the surface temperature of the plastic case could exceed 85 °C
- In order to provide strain relief and to avoid transmitting excessive vibration to the modem during installation, all cables connected to the MTX-T modem must be secured or clamped immediately adjacent to the modem’s connectors
- To protect the power supply cables, and in order to comply with fire safety requirements, when the unit is powered from a battery or a high current supply, a fast 1.25A fuse should be connected in line with the positive supply
- Any incompatible components or products must not be connected to the MTX-T modem

Note: MTX-T distributors and sales offices may refuse warranty claims where evidence of product misuse is found.

### ● 3. SIM Card Precautions

Before handling the SIM card in your application, ensure that you are not charged with static electricity. Use proper precautions to avoid electrostatic discharges.

- When the SIM card hatch is opened, the SIM card connectors lie exposed under the SIM card holder

**Caution!** Do not touch these connectors! If you do, you may release an electrical discharge that could damage the modem or the SIM card.

- When designing your application, the SIM card's accessibility should be taken into account. We always recommend that you have the SIM card protected by a PIN code. This will ensure that the SIM card cannot be used by an unauthorized person

## ● 4. Antenna Precautions

If the antenna is to be mounted outside, consider the risk of lightning. Follow the instructions provided by the antenna manufacturer.

- Never connect more than one modem to a single antenna. The modem can be damaged by radio frequency energy from the transmitter of another modem
- Like any mobile station, the antenna of the modem emits radio frequency energy. To avoid EMI (electromagnetic interference), you must determine whether the application itself, or equipment in the application's proximity, needs further protection against radio emission and the disturbances it might cause. Protection is secured either by shielding the surrounding electronics or by moving the antenna away from the electronics and the external signal cable
- The modem and antenna may be damaged if either come into contact with ground potentials other than the one in your application. Beware: ground potentials are not always what they appear to be



## ● 5. Radio Frequency (RF) Exposure and SAR

Your wireless modem device is a low-power radio transmitter and receiver (transceiver). When it is turned on, it emits low levels of radio frequency energy (also known as radio waves or radio frequency fields).

Governments around the world have adopted comprehensive international safety guidelines, developed by scientific organizations such as ICNIRP (International Commission on Non-Ionizing Radiation Protection) and IEEE (The Institute of Electrical and Electronics Engineers Inc.), through periodic and thorough evaluation of scientific studies. These guidelines establish permitted levels of radio wave exposure for the general population. The levels include a safety margin designed to assure the safety of all persons, regardless of age and health, and to account for any variations in measurements.

Specific Absorption Rate (SAR) is the unit of measurement for the amount of radio frequency energy absorbed by the body when using a transceiver. The SAR value is determined at the highest certified power level in laboratory conditions, but the actual SAR level of the transceiver while operating can be well below this value. This is because the transceiver is designed to use the minimum power required to reach the network.

The MTX-T wireless modem device has been approved for applications where the antenna is located more than 20cm from the body. In all other configurations the user is responsible for meeting the local SAR regulations.

Users of the MTX-T wireless modem device are responsible for ensuring that they meet the SAR regulatory requirements of the countries in which they intend to operate the device and that their documentation contains the relevant SAR declaration, certification information and user guidance as appropriate.

## ● 6. Personal Medical Devices

Wireless modem devices may affect the operation of cardiac pacemakers, hearing aids and certain other implanted equipment. If a minimum distance of 15 cm (6 inches) is maintained between the MTX-T modem radiating antenna and a pacemaker, the risk of interference is limited. If the user's application is likely to be situated in the vicinity of personnel, a suitable warning should be contained in the equipment manual to this effect.

# MODEM INSTALLATION

This chapter gives you advice and helpful hints on how to integrate the MTX-3G-T Terminal into your application from a hardware perspective.

## ● 1. Where to Install the Modem

There are several conditions which need to be taken into consideration when designing your application as they might affect the modem and its function. They are:

### 1.1 Environmental conditions

The modem must be installed so that the environmental conditions stated in the Technical Data chapter such as temperature, humidity and vibration are satisfied.

Additionally, the electrical specifications in the Technical Data section must not be exceeded.

### 1.2 Signal strength

The modem has to be placed in a way that ensures sufficient signal strength. To improve signal strength, the antenna can be moved to another position. Signal strength may depend on how close the modem is to a radio base station. You must ensure that where you intend to use the modem is within the network coverage area. Degradation in signal strength can be the result of disturbance from another source; for example, an electronic device in the immediate vicinity. More information about possible communication disturbances can be found in section Operation 3.5 (Possible communications disturbances).

When an application is completed, you can verify the signal strength by issuing the AT command AT+CSQ.

**Tip!** Before installing the modem, use an ordinary mobile telephone to check a possible location for it. In determining the location for the modem and antenna, you should consider signal strength as well as cable length.

### 1.3 Connections of components to MTX-T device

The user is responsible for the final integrated system. If not correctly designed or installed, external components may cause radiation limits to be exceeded. For instance, improperly made connections or improperly installed antennas can disturb the network and lead to malfunctions in the modem.

### 1.4 Network and subscription

Before your application is used, you must ensure that your chosen network provides the necessary telecommunication services. Contact your service provider to obtain the necessary information.

- If you intend to use SMS in the application, ensure this is included in your (voice) subscription
- Consider the choice of supplementary services

## ● 2. How to Install the Modem

### 2.1 Power supply

Use a high-quality power supply cable with low resistance. This ensures that the voltages at the connector pins are within the allowed range, even during the maximum peak current.

When the unit is powered from a battery or a high current supply, connect a fast 1.25A fuse in line with the positive supply. This protects the power cabling and modem.

### 2.2 Securing the modem

Before securing the modem take into account the amount of additional space required for the mating connectors and cables that will be used in the application.

- Where access is restricted, it may be easier to connect all the cables to the modem prior to securing it in the application
- Securely attach the MTX-T Terminal modem to the host application using two 3mm diameter pan-head screws

## ● 3. Antenna

### 3.1 General

The antenna is the component in your system that maintains the radio link between the network and the modem. Since the antenna transmits and receives electromagnetic energy, its efficient function will depend on:

- The type of antenna (for example, circular or directional)
- The placement of the antenna
- Communication disturbances in the vicinity in which the antenna operates

In the sections below, issues concerning antenna type, antenna placement, antenna cable, and possible communication disturbances are addressed. In any event, you should contact your local antenna manufacturer for additional information concerning antenna type, cables, connectors, antenna placement, and the surrounding area.

You should also determine whether the antenna needs to be grounded or not. Your local antenna manufacturer might be able to design a special antenna suitable for your application.

### 3.2 Antenna type

Make sure that you choose the right type of antenna for the modem. Consider the following requirements:

- The antenna must be designed for one of the frequency bands in use; please ask your network provider for more information:
  - LTE 700/800/900/1800/2100 MHz
  - UMTS 800/850/900/1900/2100 MHz
  - GSM 850/900/1800/1900 MHz
- The impedance of the antenna and antenna cable must be 50Ω
- The antenna output-power handling must be a minimum of 2W

### 3.3 Antenna placement

The antenna should be placed away from electronic devices and other antennas. The recommended minimum distance between adjacent antennas, operating in a similar radio frequency band, is at least 50cm. If the signal strength is weak, it is useful to face a directional antenna towards the closest radio base station. This can increase the strength of the signal received by the modem. The modem's peak output power can reach 2W.

RF field strength varies with antenna type and distance. At 10cm from the antenna the field strength may be up to 70V/m and at 1m it will have reduced to 7V/m. In general, CE-marked products for residential / commercial areas and the light industry can withstand a minimum of 3V/m.

### 3.4 The antenna cable

Use 50Ω impedance low-loss cable and high-quality 50Ω impedance connectors (frequency range up to 3GHz) to avoid RF losses. Ensure that the antenna cable is as short as possible. The Voltage Standing-Wave Ratio (VSWR) may depend on the effectiveness of the antenna, cable and connectors. In addition, if you use an adaptor between the antenna cable and the antenna connector, it is crucial that the antenna cable is a high-quality, low-loss cable. Minimize the use of extension cables, connectors and adapters. Each additional cable, connector or adapter causes a loss of signal power.

### 3.5 Possible communications disturbances

Possible communication disturbances include the following:

- Noise can be caused by electronic devices and radio transmitters
- Path-loss occurs as the strength of the received signal steadily decreases in proportion to the distance from the transmitter
- Shadowing is a form of environmental attenuation of radio signals caused by hills, buildings, trees or even vehicles. This can be a particular problem inside buildings, especially if the walls are thick and reinforced
- Multi-path fading is a sudden decrease or increase in the signal strength. This is the result of interference which is caused when direct and reflected signals reach the antenna simultaneously. Surfaces such as buildings, streets, vehicles, etc., can reflect signals
- Hand-over occurs as you move from one cell to another in the GSM network. Your mobile application call is transferred from one cell to the next. Hand-over can briefly interfere with communication and may cause a delay, or at worst, disruption

# CONFORMITY ASSESSMENT

## ● 1. RED Declaration of Conformity

Unique identification of this DoC: MTX-3G-T-IoT RED DoC

We

MATRIX ELECTRÓNICA S.L., C/ Alejandro Sanchez 109, 28019 Madrid, Spain

declare under our sole responsibility that the MTX-3G-T-IoT family product

MTX-2G-T	199801421
MTX-3G-T	199801422
MTX-3G-T-G (GPS)	199801423
MTX-4G-T (4G/2G)	199801424
MTX-4G-T (4G/3G/2G)	199801445

terminal containing Cellular Engine EHS6/EHS8 type L30960-N2950-A300/L30960-N2900-A300 object of the declaration described above is in conformity with the relevant Union harmonization Legislation:

RED Directive 2014/53/EU and R&TTE Directive 99/5/EC.

The following harmonized standards and/or other normative documents were applied and are labeled with the CE conformity mark.



- EMC (art 3.1.b): EN 301 489-1 V2.2.0, EN 301 489-52 V1.1.0, EN 301 489-3 V2.1.1
- RADIO SPECTRUM (art 3. 2): EN 301 511 V12.5.1, EN 301 908-1 V11.1.1, EN 301 908-2 V11.1.1, EN 300 440 V2.1.1
- SAFETY (art 3.1.a): EN 60950-1:2006 + A11:2009 + A1:2010 + A12:2011 + A2:2013
- RF SAFETY: EN62311:2008

The technical documentation relevant to the above equipment will be held at:

MATRIX ELECTRÓNICA S.L., C/ Alejandro Sanchez 109, 28019 Madrid, Spain

Madrid, 05/30/2017

Mr. J. Vicente

Managing Board

## ● 2. FCC Compliant

MTX-T and any variants contain FCC ID: QIPEHS6. The FCC Equipment Authorization Certification for the EHS6 Module is listed under the FCC identifier QIPEHS6.

Industry Canada Certification Number: 7830A-EHS6 granted to Gemalto M2M GmbH.

The reference application of the EHS6 Module registered under the above identifier is certified to be in accordance with the following Rules and Regulations of the Federal Communications Commission (FCC). Power listed is ERP for Part 22 and EIRP for Part 24. It is compliant with FCC regulations.

Equipment class: PCS Licensed Transmitter

Notes: Quad band GSM/GPRS Modem

### 2.1 SAR information

Wireless Modules models: EHS6 is marketed without a defined antenna.

The Maximum Antenna Gain when using indoor antennas depends on the distance from the antenna to any nearby persons when in normal operation. It should not exceed the values shown on the table below.

According to the limit in 47 CFR 1.1310, we get the value of the maximum antenna gain as follows:

The maximum measured power output in the 850 MHz band is 1866.38 mW (32.71 dBm, see 7layers test report MDE\_Siem\_0714\_FCCb).

The maximum permissible exposure is defined as 47 CFR 1.1310 with 0.55773 mW/cm<sup>2</sup>.

The maximum measured power output in the 1900 MHz band is 974.99 mW (29.89 dBm, see 7layers test report MDE\_Siem\_0714\_FCCc).

The maximum permissible exposure is defined as 47 CFR 1.1310 with 1 mW/cm<sup>2</sup>.

According to the limit in 47 CFR 1.1310, we get the value of the maximum antenna gain as follows:

$$S = P \cdot G / 4\pi R^2$$

$$S = 0.55773 \text{ mW/cm}^2 \text{ or } 1 \text{ mW/cm}^2$$

$$P = 1866.38 \text{ mW or } 974.99 \text{ mW}$$

$$R = 20 \text{ cm or } 100 \text{ cm}$$

$$\pi = 3.1416$$

$$G(\text{dBi}) = 10 \cdot \log_{10}(G)$$



Solving for G; the maximum antenna gain is:

BAND	DISTANCE	MAX. GAIN (dBi)
850MHz	20cm	1.7669
850MHz	50cm	9.7257
1900MHz	20cm	7.1227
1900MHz	50cm	15.0815

# DECLARACIÓN DE CONFORMIDAD

## ● 1. Declaración de conformidad RED

Identificación única de esta Declaración de Conformidad: MTX-3G-T-IoT RED DoC

Nosotros

MATRIX ELECTRÓNICA S.L., C/ Alejandro Sanchez 109, 28019 Madrid, España

declaramos bajo nuestra responsabilidad que la familia de productos MTX-3G-T-IoT

MTX-2G-T	199801421
MTX-3G-T	199801422
MTX-3G-T-G (GPS)	199801423
MTX-4G-T (4G/2G)	199801424
MTX-4G-T (4G/3G/2G)	199801445

que contienen un módulo celular EHS6 (tipo L30960-N2950-A100), al cual se refiere esta declaración, están conformes con:

Directiva RED 2014/53/EU y R&TTE 99/5/EC.

Estos estándares armonizados permiten etiquetar al producto con el marcado CE.



- EMC (art 3.1.b): EN 301 489-1 V2.2.0, EN 301 489-52 V1.1.0, EN 301 489-3 V2.1.1
- RADIO SPECTRUM (art 3. 2): EN 301 511 V12.5.1, EN 301 908-1 V11.1.1, EN 301 908-2 V11.1.1, EN 300 440 V2.1.1
- SAFETY (art 3.1.a): EN 60950-1:2006 + A11:2009 + A1:2010 + A12:2011 + A2:2013
- RF SAFETY: EN62311:2008

La documentación técnica referente al equipo anterior está disponible en:

MATRIX ELECTRÓNICA S.L., C/ Alejandro Sanchez 109, 28019 Madrid, España

Madrid, 30/05/2017

Sr. J. Vicente

Junta Directiva

## ● 2. Conformidad FCC

MTX-T y todas sus variantes contienen el FCC ID: QIPEHS6. El Certificado de Autorización de Equipo de la FCC para el módulo EHS6 está listado con el identificador FCC QIPEHS6.

Número de Certificación de Industria en Canadá: 7830A-EHS6 asignado a Gemalto M2M GmbH.

El formulario de referencia del módulo EHS6 registrado bajo el anterior identificador está conforme con las siguientes Reglas y Regulaciones de la Comisión Federal de Comunicaciones (FCC). La potencia listada como ERP para la parte 22 y como EIRP para la parte 24 cumple con las regulaciones de la FCC.

Clase de equipo: Transmisor PCS Licenciado

Notas: Quad band GSM/GPRS Modem

### 2.1 Tasa de absorción específica (SAR)

El modulo EHS6 es comercializado sin una antena definida. La ganancia máxima de antena usando antenas de interior depende de la distancia de esta a las personas cercanas y en condiciones normales no debe sobrepasar los límites mostrados en la tabla siguiente.

La máxima potencia de salida medida en la banda de 850MHz es 1866.38 mW (32.71 dBm, ver el reporte de test de 7layers MDE\_Siem\_0714\_FCCb).

La máxima exposición permisible se define en 47 CFR 1.1310 con un valor de 0.55773 mW/cm<sup>2</sup>.

La máxima potencia de salida medida en la banda de 1900 MHz es 974.99 mW (29.89 dBm, ver el reporte de test de 7layers MDE\_Siem\_0714\_FCCc).

La máxima exposición permisible se define en 47 CFR 1.1310 con un valor de 1 mW/cm<sup>2</sup>.

De acuerdo al límite en 47 CFR 1.1310, obtenemos el valor de la máxima ganancia de antena como sigue:

$$S = P \cdot G / 4\pi R^2$$

$$S = 0.55773 \text{ mW/cm}^2 \text{ o } 1 \text{ mW/cm}^2$$

$$P = 1866.38 \text{ mW o } 974.99 \text{ mW}$$

$$R = 20 \text{ cm o } 100\text{cm}$$

$$\pi = 3.1416$$

$$G(\text{dBi}) = 10 \cdot \log_{10}(G)$$

Despejando G; la máxima ganancia de antena es:

BANDA	DISTANCIA	GANANCIA MÁX. (dBi)
850MHz	20cm	17669
850MHz	50cm	97257
1900MHz	20cm	71227
1900MHz	50cm	150815

# REGULATORY AND TYPE APPROVAL INFORMATION

## ● 1. Directives and Standards

The MTX-T modem has been designed to comply with the directives and standards listed below.

It is the responsibility of the application manufacturer to ensure compliance of the final product with all provisions of the applicable directives and standards, as well as with the technical specifications provided in this document.

DIRECTIVES	
RED Directive 2014/53/EU and R&TTE Directive 99/5/EC	Directive of the European Parliament on radio equipment and telecommunications terminal equipment and the mutual recognition of their conformity .  The product is labeled with the CE conformity mark.
ECE-R 10	Economic Commission for Europe (ECE) Regulation No. 10: Uniform provisions concerning the approval of vehicles with regard to electromagnetic compatibility.
2002/95/EC (RoHS 1) 2011/65/EC (RoHS 2)	Directive of the European Parliament and of the Council of 27 January 2003 (and revised on 8 June 2011) on the restriction of the use of certain hazardous substances in electrical and electronic equipment (RoHS).

STANDARDS OF NORTH AMERICAN TYPE APPROVAL	
CFR Title 47	Code of Federal Regulations, Part 22 and Part 24 (Telecommunications, PCS); US Equipment Authorization FCC.
OET Bulletin 65 (Edition 97-01)	Evaluating Compliance with FCC Guidelines for Human Exposure to Radiofrequency Electromagnetic Fields.
UL 60 950-1	Product Safety Certification (Safety requirements).
NAPRD.03 V5.15	Overview of PCS Type certification review board Mobile Equipment Type. Certification and IMEI control. PCS Type Certification Review board (PTCRB).
RSS132 (Issue2) RSS133 (Issue5)	Canadian Standard.

## STANDARDS OF EUROPEAN TYPE APPROVAL

3GPP TS 51.010-1	Digital cellular telecommunications system (Release 7); Mobile Station (MS) conformance specification.
ETSI EN 301 511 V9.0.2	Global System for Mobile communications (GSM); Harmonized standard for mobile stations in the GSM 900 and DCS 1800 bands covering essential requirements under article 3.2 of the R&TTE directive (1999/5/EC).
GCF-CC V3.49	Global Certification Forum - Certification Criteria.
ETSI EN 301 489-01 V1.9.2	Electromagnetic Compatibility and Radio spectrum Matters (ERM); Electromagnetic Compatibility (EMC) standard for radio equipment and services; Part 1: Common Tech. Requirements.
ETSI EN 301 489-07 V1.3.1	Electromagnetic Compatibility and Radio spectrum Matters (ERM); Electromagnetic Compatibility (EMC) standard for radio equipment and services; Part 7: Specific conditions for mobile and portable radio and ancillary equipment of digital cellular radio telecommunications systems (GSM and DCS).
ETSI EN 301 489-24 V1.5.1	Electromagnetic Compatibility and Radio spectrum Matters (ERM); Electromagnetic Compatibility (EMC) standard for radio equipment and services; Part 24: Specific conditions for IMT-2000 CDMA Direct Spread (UTRA) for Mobile and portable (UE) radio and ancillary equipment.
EN 301 908-01 V5.2.1	Electromagnetic compatibility and Radio spectrum Matters (ERM); Base Stations (BS) and User Equipment (UE) for IMT-2000 Third Generation cellular networks; Part 1: Harmonized EN for IMT-2000, introduction and common requirements of article 3.2 of the R&TTE Directive.
EN 301 908-02 V5.2.1	Electromagnetic compatibility and Radio spectrum Matters (ERM); Base Stations (BS) and User Equipment (UE) for IMT-2000 Third Generation cellular networks; Part 2: Harmonized EN for IMT-2000, CDMA Direct Spread (UTRA FDD) (UE) covering essential requirements of article 3.2 of the R&TTE Directive.
EN 62311:2008	Assessment of electronic and electrical equipment related to human exposure restrictions for electromagnetic fields (0 Hz - 300 GHz).
IEC/EN 60950-1:2006+A11:2009+A1:2010+A12:2011	Safety of information technology equipment.

## REQUIREMENTS OF QUALITY

IEC 60068 Environmental testing.

DIN EN 60529 IP codes.

## STANDARDS OF THE MINISTRY OF INFORMATION INDUSTRY OF THE REPUBLIC OF CHINA

SJ/T 11363-2006 “Requirements for Concentration Limits for Certain Hazardous Substances in Electronic Information Products.” (2006-06)

“Marking for Control of Pollution Caused by Electronic Information Products.” (2006-06)

SJ/T 11364-2006

According to the “Chinese Administration on the Control of Pollution caused by Electronic Information Products” (ACPEIP) the EPUP, i.e., Environmental Protection Use Period, of this product is 20 years as per the symbol shown here, unless otherwise marked. The EPUP is valid only as long as the product is operated within the operating limits described in the Gemalto M2M Hardware Interface Description?

Please see next table for an overview of toxic or hazardous substances or elements that might be contained in product parts in concentrations above the limits defined by SJ/T 11363-2006.

部件名称 Name of the part	有毒有害物质或元素 Hazardous substances					
	铅 (Pb)	汞 (Hg)	镉 (Cd)	六价铬 (Cr(VI))	多溴联苯 (PBB)	多溴二苯醚 (PBDE)
金属部件 (Metal Parts)	○	○	○	○	○	○
电路模块 (Circuit Modules)	X	○	○	○	○	○
电缆及电缆组件 (Cables and Cable Assemblies)	○	○	○	○	○	○
塑料和聚合物部件 (Plastic and Polymeric parts)	○	○	○	○	○	○

O:  
表示该有毒有害物质在该部件所有均质材料中的含量均在SJ/T11363-2006 标准规定的限量要求以下。  
Indicates that this toxic or hazardous substance contained in all of the homogeneous materials for this part is below the limit requirement in SJ/T11363-2006.

X:  
表示该有毒有害物质至少在该部件的某一均质材料中的含量超出SJ/T11363-2006标准规定的限量要求。  
Indicates that this toxic or hazardous substance contained in at least one of the homogeneous materials used for this part *might* exceed the limit requirement in SJ/T11363-2006.

## ● 2. SAR Requirements Specific to Portable Mobiles

Mobile phones, PDAs or other portable transmitters and receivers incorporating a GSM module must be in accordance with the guidelines for human exposure to radio frequency energy. This requires the Specific Absorption Rate (SAR) of portable EHS6 based applications to be evaluated and approved for compliance with national and/or international regulations.

Since the SAR value varies significantly with the individual product design, manufacturers are advised to submit their product for approval if designed for portable use. For European markets the relevant directives are mentioned below. It is the responsibility of the manufacturer of the final product to verify whether or not further standards, recommendations or directives are in force outside these areas.

### **Products intended for sale in US markets**

EN 59005/ANSI C95.1: Considerations for evaluation of human exposure to Electromagnetic Fields (EMFs) from Mobile Telecommunication Equipment (MTE) in the frequency range 30MHz – 6GHz

### **Products intended for sale in European markets**

EN 50360: Product standard to demonstrate the compliance of mobile phones with the basic restrictions related to human exposure to electromagnetic fields (300MHz - 3GHz)

Please note that SAR requirements are specific only for portable devices and not for mobile devices as defined below:

- Portable device: A portable device is defined as a transmitting device designed to be used so that the radiating structure(s) of the device is/are within 20 centimeters of the user's body.
- Mobile device: A mobile device is defined as a transmitting device designed to be used in other than fixed locations and to generally be used in such a way that a separation distance of at least 20 centimeters is normally maintained between the transmitter's radiating structure(s) and the user's body or that of nearby persons. In this context, the term "fixed location" means that the device is physically secured at one location and cannot be easily moved to another location.



### ● 3. SELV Requirements

The power supply connected to the MTX-T modem shall be in compliance with the SELV requirements defined in EN 60950-1.

# ROHS STATEMENT

The MTX-T modem is compliant with the 2002/95/EC (RoHS 1) and 2011/65/EC (RoHS 2) directives of the European Parliament and of the Council of 27 January 2003 (and revised on 8 June 2011) on the restriction of the use of certain hazardous substances in electrical and electronic equipment (RoHS).



# DISPOSAL OF OLD ELECTRICAL AND ELECTRONIC EQUIPMENT



This symbol, applied on our products and/or on its packaging, indicates that this product should not be treated as household waste when you wish to dispose of it. Instead, it should be handed over to an applicable collection point for the recycling of electrical and electronic equipment. By ensuring this product is disposed of correctly, you will help prevent potential negative consequences to the environment and human health, which could otherwise be caused by inappropriate disposal of this product. The recycling of materials will help to conserve natural resources. For more detailed information about the recycling of this product, please contact your local city office, household waste disposal service or the retail store where you purchased this product.

# ABBREVIATIONS

ABBREVIATIONS	DESCRIPTION
ADC	Analog-to-digital converter
AGC	Automatic Gain Control
ANSI	American National Standards Institute
ARFCN	Absolute Radio Frequency Channel Number
ARP	Antenna Reference Point
ASCO/ASC1	Asynchronous Controller. Abbreviations used for first and second serial interface of EHS6
B	Thermistor Constant
VER	Bit Error Rate
BTS	Base Transceiver Station
CB or CBM	Cell Broadcast Message
CE	Conformité Européene (European Conformity)
CHAP	Challenge Handshake Authentication Protocol
CPU	Central Processing Unit
CS	Coding Scheme
CSD	Circuit Switched Data
CTS	Clear to Send
DAC	Digital-to-Analog Converter
DAI	Digital Audio Interface
dBm0	Digital level, 3.14dBm0 corresponds to full scale, see ITU G.711, A-law

DCE	Data Communication Equipment (typically modems, e.g. Gemalto M2M module)
DCS 1800	Digital Cellular System, also referred to as PCN
DL	Download
Dnu	Do not use
DRX	Discontinuous Reception
DSB	Development Support Box
DSP	Digital Signal Processor
DSR	Data Set Ready
DTE	Data Terminal Equipment (typically a computer, terminal, printer or, for example, a GSM application)
DTR	Data Terminal Ready
DTX	Discontinuous Transmission
EDGE	Enhanced Data rates for GSM Evolution
EFR	Enhanced Full Rate
EGSM	Enhanced GSM
EIRP	Equivalent Isotropic Radiated Power
EMC	Electromagnetic Compatibility
ERP	Effective Radiated Power
ESD	Electrostatic Discharge
ETS	European Telecommunication Standard
ETSI	European Telecommunications Standards Institute
FCC	Federal Communications Commission (U.S.)

FDD	Frequency Division Duplex
FDMA	Frequency Division Multiple Access
FR	Full Rate
GMSK	Gaussian Minimum Shift Keying
GPIO	General Purpose Input/Output
GPRS	General Packet Radio Service
GSM	Global Standard for Mobile Communications
HiZ	High Impedance
HR	Half Rate
HSDPA	High Speed Downlink Packet Access
I/O	Input/Output
IC	Integrated Circuit
IMEI	International Mobile Equipment Identity
ISO	International Standards Organization
ITU	International Telecommunications Union
kbps	kbits per second
LED	Light Emitting Diode
Li-Ion/Li+	Lithium-Ion
Li battery	Rechargeable Lithium Ion or Lithium Polymer battery
LPM	Link Power Management
MBB	Moisture barrier bag
Mbps	Mbits per second

MCS	Modulation and Coding Scheme
MMI	Man Machine Interface
MO	Mobile Originated
MS	Mobile Station (GSM module), also referred to as TE
MSISDN	Mobile Station International ISDN number
MSL	Moisture Sensitivity Level
MT	Mobile Terminated
nc	Not connected
NTC	Negative Temperature Coefficient
OEM	Original Equipment Manufacturer
PA	Power Amplifier
PAP	Password Authentication Protocol
PBCCH	Packet Switched Broadcast Control Channel
PCB	Printed Circuit Board
PCL	Power Control Level
PCM	Pulse Code Modulation
PCN	Personal Communications Network, also referred to as DCS 1800
PCS	Personal Communication System, also referred to as GSM 1900
PD	Pull Down resistor (appr. 100k)
PDU	Protocol Data Unit
PLL	Phase Locked Loop
PPP	Point-to-point protocol

PS	Packet Switched
PSK	Phase Shift Keying
PSU	Power Supply Unit
PU	Pull Up resistor (appr. 100k)
PWM	Pulse Width Modulation
QAM	Quadrature Amplitude Modulation
R&TTE	Radio and Telecommunication Terminal Equipment
RAM	Random Access Memory
RF	Radio Frequency
RLS	Radio Link Stability
RMS	Root Mean Square (value)
RoHS	Restriction of the use of certain hazardous substances in electrical and electronic equipment
ROM	Read-only Memory
RTC	Real Time Clock
RTS	Request to Send
Rx	Receive Direction
SAR	Specific Absorption Rate
SAW	Surface Acoustic Wave
SELV	Safety Extra Low Voltage
SIM	Subscriber Identification Module
SMD	Surface Mount Device



SMS	Short Message Service
SMT	Surface Mount Technology
SPI	Serial Peripheral Interface
SRAM	Static Random Access Memory
SRB	Signalling Radio Bearer
TA	Terminal adapter (e.g. GSM module)
TDMA	Time Division Multiple Access
TE	Terminal Equipment, also referred to as DTE
TLS	Transport Layer Security
TPC	Transmit Power Control
TS	Technical Specification
Tx	Transmit Direction
UART	Universal asynchronous receiver-transmitter
UICC	USIM Integrated Circuit Card
UL	Upload
UMTS	Universal Mobile Telecommunications System
URC	Unsolicited Result Code
USB	Universal Serial Bus
USIM	UMTS Subscriber Identification Module
USSD	Unstructured Supplementary Service Data
VSWR	Voltage Standing Wave Ratio
WCDMA	Wideband Code Division Multiple Access

# AT COMMAND SUMMARY

The AT standard is a line-oriented command language. AT is an abbreviation of ATtention and it is always used to send a command line from the terminal equipment (TE) to the terminal adaptor (TA).

The command line consists of a string of alphanumeric characters. It is sent to the MTX-T to instruct it to perform the commands specified by the characters.

The AT commands listed below are supported from within the MTX-T. The AT Command Set manual can be downloaded from the MTX-T web page at [www.mtxm2m.com](http://www.mtxm2m.com).

AT COMMAND	DESCRIPTION
+++	Switch from data mode or PPP online mode to command mode
A/	Repeat Previous Command Line
AT&C	Set Data Carrier Detect (DCD) Line Mode
AT&D	Set Data Terminal Ready (DTR) Line Mode
AT&F	Reset AT Command Settings to Factory Default Values
AT&S	Set Data Set Ready (DSR) Line Mode
AT&V	Display current configuration
AT&W	Store AT Command Settings to User Defined Profile
AT+CACM	Accumulated call meter (ACM) reset or query
AT+CALA	Alarm Configuration
AT+CAMM	Accumulated call meter maximum (ACMmax) set or query
AT+CAOC	Advise of Charge Information
AT+CBST	Select Bearer Service Type
AT+CCFC	Call forwarding number and conditions control
AT+CCID	USIM Card Identification Number
AT+CCLK	Real Time Clock

AT+CCUG	Closed User Group
AT+CCWA	Call Waiting
AT+CEER	Extended Error Report
AT+CFUN	Functionality Level
AT+CGACT	PDP context activate or deactivate
AT+CGANS	Manual response to a network request for PDP context activation
AT+CGATT	GPRS attach or detach
AT+CGAUTO	Automatic response to a network request for PDP context activation
AT+CGCMOD	PDP Context Modify
AT+CGDATA	Enter data state
AT+CGDCONT	Define PDP Context
AT+CGEQMIN	Rel. 99 Quality of Service Profile (Minimum acceptable)
AT+CGEQREQ	Rel. 99 Quality of Service Profile (Requested)
AT+CGEREP	GPRS event reporting
AT+CGMI	Request manufacturer identification
AT+CGMM	Request model identification
AT+CGMR	Request revision identification of software status
AT+CGPADDR	Show PDP address
AT+CGQMIN	Quality of Service Profile (Minimum acceptable)
AT+CGQREQ	Quality of Service Profile (Requested)
AT+CGREG	Packet Domain Network Registration Status
AT+CGSMS	Select service for MO SMS messages

AT+CGSN	Request International Mobile Equipment Identity (IMEI)
AT+CHLD	Call Hold and Multiparty
AT+CHUP	Hang up call
AT+CIMI	Request International Mobile Subscriber Identity (IMSI)
AT+CLCC	List of current calls
AT+CLCK	Facility lock
AT+CLIP	Calling Line Identification Presentation
AT+CLIR	Calling Line Identification Restriction
AT+CMEE	Error Message Format
AT+CMGC	Send SMS Command
AT+CMGD	Delete short message
AT+CMGF	Select SMS message format
AT+CMGL	List SMS messages from preferred store
AT+CMGR	Read SMS messages
AT+CMGS	Send SMS
AT+CMGW	Write Short Messages to Memory
AT+CMMS	More Messages to Send
AT+CMSS	Send short messages from storage
AT+CMUT	Mute control
AT+CMUX	Multiplex mode
AT+CNAP	Calling Name Presentation
AT+CNMA	New Message Acknowledgement to ME/TE

AT+CNMI	SMS Event Reporting Configuration
AT+CNUM	Read own numbers
AT+COLP	Connected Line Identification Presentation
AT+COPN	Read operator names
AT+COPS	Operator Selection
AT+CPAS	Activity Status
AT+CPBF	Find phonebook entries
AT+CPBR	Read from Phonebook
AT+CPBS	Select phonebook memory storage
AT+CPBW	Write into Phonebook
AT+CPIN	PIN Authentication
AT+CPIN2	PIN2 Authentication
AT+CPLS	Select Preferred Operator List
AT+CPMS	Preferred SMS message storage
AT+CPOL	Preferred Operator List
AT+CPUC	Price per unit and currency table
AT+CPWD	Change Password
AT+CR	Service reporting control
AT+CRC	Incoming Call Indication Format
AT+CREG	Network Registration Status
AT+CRLP	Configure RLP Parameters for Outgoing Non-Transparent Data Calls
AT+CRSM	Restricted SIM Access

AT+CSCA	SMS Service Center Address
AT+CSCB	Select Cell Broadcast Message Indication
AT+CSCS	Character Set
AT+CSDH	Show SMS text mode parameters
AT+CSIM	Generic USIM Access
AT+CSMP	Set SMS Text Mode Parameters
AT+CSMS	Select Message Service
AT+CSQ	Signal quality
AT+CSSN	Supplementary service notifications
AT+CSTA	Select type of address
AT+CSVM	Set voice mail number
AT+CTZR	Time Zone Reporting
AT+CTZU	Automatic Time Zone Update
AT+CUSD	Unstructured Supplementary Service Data
AT+GSN	Request International Mobile Equipment Identity (IMEI)
AT+IPR	Bit Rate
AT+STKCC	USAT Call Control Notification
AT+STKCNF	USAT Proactive Session Status
AT+STKENV	USAT Envelope Command
AT+STKPRO	USAT Proactive Command URCs
AT+STKTR	USAT Terminal Response Commands
AT+VTD	Tone duration

AT+VTS	DTMF and tone generation
AT\Q	Flow Control
AT^SBV	Battery/Supply Voltage
AT^SCCNT	Configure Pulse Counter
AT^SCFG	Extended Configuration Settings
AT^SCPIN	Pin Configuration
AT^SCPOL	Polling Configuration
AT^SCTM	Critical Operating Temperature Monitoring
AT^SFDL	Firmware Download
AT^SFSA	Flash File System Access
AT^SGAUTH	Set Type of Authentication for PDP-IP Connections
AT^SGIO	Get IO state of a specified pin or port
AT^SHUP	Hang up call(s) indicating a specific 3GPP TS 24.008 release cause
AT^SICI	Internet Connection Information
AT^SICS	Internet Connection Setup Profile
AT^SIND	Extended Indicator Control
AT^SIPS	Internet Profile Storage
AT^SISC	Internet Service Close
AT^SISE	Internet Service Error Report
AT^SISH	Internet Listener Service Disconnect
AT^SISI	Internet Service Information
AT^SISO	Internet Service Open

AT^SISR	Internet Service Read Data
AT^SISS	Internet Service Setup Profile
AT^SIST	Enter Transparent Access Mode
AT^SISW	Internet Service Write Data
AT^SISX	Internet Service Execution
AT^SJAM	Manage Java Application
AT^SJDL	Java Download
AT^SJMSEC	Java Midlet Security
AT^SJNET	Set Dialup Network Access Parameters
AT^SJOTAP	Over The Air Application Provisioning
AT^SJRA	Run Java Application
AT^SLED	LED Feature
AT^SMGL	List Short Messages from preferred store without setting status to REC READ
AT^SMGR	Read short message without setting status to REC READ
AT^SMONI	Monitoring Serving Cell
AT^SMONP	Monitoring Neighbour Cells
AT^SMSO	Switch Off EHS6
AT^SNFI	Set microphone path parameters
AT^SNFM	Set microphone audio path and power supply
AT^SNFO	Set audio output (= loudspeaker path) parameter
AT^SNFS	Select audio hardware set



AT^SNFTTY	Signal TTY/CTM audio mode capability
AT^SNMON	Network monitoring
AT^SPIO	GPIO Driver Open/Close
AT^SRADC	Configure and Read ADC Measurement
AT^SRTC	Ring tone configuration
AT^SSCNT	Start and Stop Pulse Counter
AT^SSIO	Set IO state of a specified pin or port
AT^SSPI	Serial Protocol Interface
AT^SSTA	Remote-SAT Interface Activation
AT^SWDAC	PWM Signal Configuration for DAC
AT^SXCALLSTAT	Set Reporting Call Status
AT^SXEONS	Display Eons names
AT^SXRAT	Selection of Radio Access Technology
ATA	Connect to Incoming Call
ATA	Manual acceptance of a network request for PDP context activation
ATD	Mobile originated call to specified number
ATD*99#	Request Packet Domain Service
ATD<<mem><n>	Mobile originated call using specific memory and index number
ATD<<n>	Mobile originated call from active memory using index number
ATD<<str>	Mobile originated call from active memory using corresponding field
ATDL	Redial last number used
ATE	AT Command Echo

ATH	Disconnect existing connection
ATI	Display product identification information
ATL	Set monitor speaker loudness
ATO	Switch from command mode to data mode/PPP online mode
ATQ	Result Code Presentation Mode
ATS0	Set number of rings before automatically answering a call
ATS10	Set disconnect delay after indicating the absence of data carrier
ATS3	Command Line Termination
ATS4	Response Formatting
ATS5	Command Line Editing
ATS6	Set pause before blind dialing
ATS7	Set number of seconds to wait for connection completion
ATS8	Comma Dial Pause Time
ATV	Result code format mode
ATX	CONN251 4ECT Result Code Format
ATZ	Restore AT Command Settings from User Defined Profile

# ACCESSORIES

The MTX-T has a wide range of available accessories, including:

- Power supplies
- All type of antennas (indoor, outdoor, high gain, etc.)
- Cables and DIN adapters

The MTX-T is shipped without any accessories.

Please visit the following web sites to see the full range of accessories: [mtxm2m.com /en/modem-router-gateway-accessories](http://mtxm2m.com/en/modem-router-gateway-accessories).

# SALES CONTACT

## MATRIX MADRID

Matrix Electrónica S.L.  
C/ Alejandro Sánchez 109  
28019 Madrid, Spain

Phone 1: 902.19.81.46  
Phone 2: +34-91.560.27.37  
Fax 1: 902.99.54.14  
Fax 2: +34-91.565.28.65

## MATRIX BARCELONA

Matrix Electrónica S.L.  
@SantCugat Business Park  
Av. Via Augusta 15-25, B2- 8, oficinas 9-10  
08174 Sant Cugat del Vallés, Barcelona, Spain

Phone: 902.19.81.46  
Fax: 902.99.54.14

## MATRIX DURANGO

Matrix Electrónica S.L.  
Pol. Aliendalde 11, oficina 2G  
48200 Durango, Vizcaya, Spain

Phone: 902.19.81.46  
Fax: 902.99.54.14

## MATRIX VALENCIA

Matrix Electrónica S.L.  
Valencia, Spain

Phone: 902.19.81.46  
Fax: 902.99.54.14

## MATRIX SEVILLA

Matrix Electrónica S.L.  
Sevilla, Spain

Phone: 902.19.81.46  
Fax: 902.99.54.14

## MATRIX LISBOA

LusoMatrix Lda.  
Av. Coronel Eduardo Galhardo 7-1º  
1170-105 Lisboa, Portugal

Phone: +351-218.162.625  
Fax: +351-218.149.482

## MATRIX CHICAGO

Matrix USA LLD  
1112 W. Boughton Rd, Suite 346  
Bolingbrook, IL 60440  
USA

[mtxm2m.com](http://mtxm2m.com)